



Technical Manual
EcoSpring 2nd Generation ALL IN ONE Type
Heat Pump Water Heater
EcoSpring ES300

Contents

Part 1 General Information	5
1. Measurements.....	6
2. External Appearance	6
3. Nomenclature.....	7
4. Features.....	8
Part 2 Outdoor Units	10
1. Specifications	11
2. Operation range	17
3. Capacity&COP table	17
4. Dimensions	17
5. Service Space	18
6. Wiring Diagrams	18
7. Piping Diagrams	20
8. Duct connection.....	17
9. Exploded View	22
Part 3 Installation	25
1. Precautions	26
2. Installation information	27
3. Unit Appearance and Composition	28
4. Accessories.....	29
5. Inspecting and Handling the Unit.....	29
6. Electric Wiring.....	29
Part 4 Trial Operation	31
1. Confirmation before the trial operation	32
2. OPERATING INSTRUCTION	32
3. PCB explanation	51
4. Maintenance	51
5. Malfunctions and Resolutions.....	53

Part 1

General Information

1. Measurements	6
2. External Appearance	6
3. Nomenclature	7
4. Features	8

1. Measurements

Model	Dimension (mm: OD x H)	Net weight / Gross weight (kg)	Power Supply
RSJ-35/300RDN3-B	Φ 650×1920	113 /129	220~240V-1ph-50Hz

2. External Appearance

RSJ-35/300RDN3-B

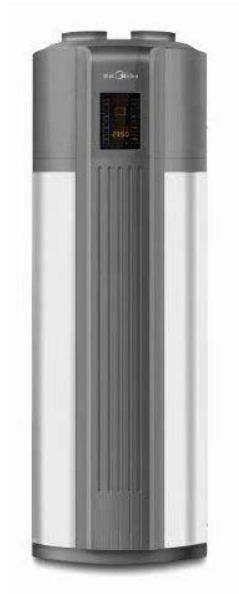

3. Nomenclature

Household Water Heating Unit

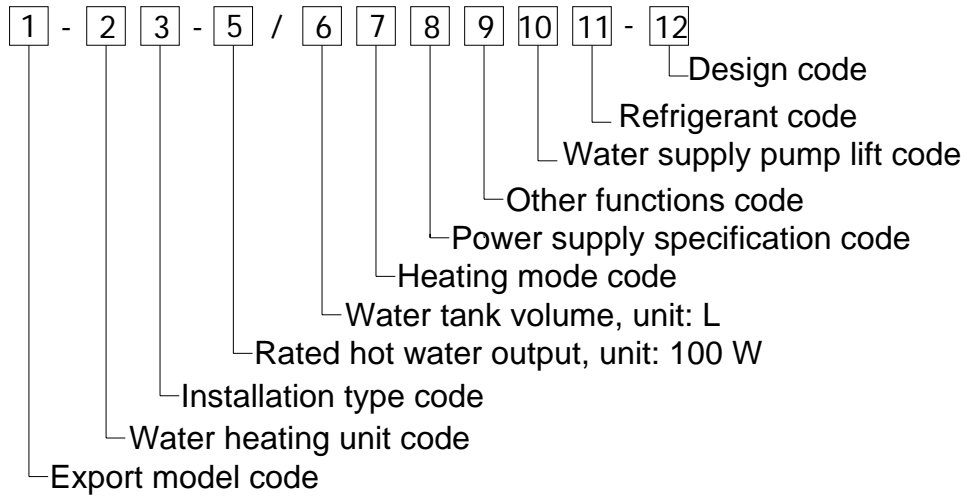

For example:

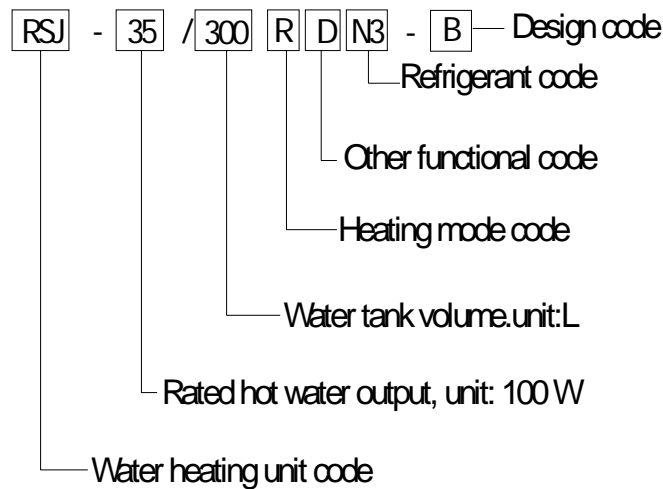

4. Features

4.1 Safety

- a. Complete isolation between water and electricity. No electric shock problem, more safety.
- b. No fuel tubes and storage, no potential danger from oil leakage, fire, explosion etc.
- c. No cross contamination potential, the condenser coil wrapped around the stainless steel inner tank

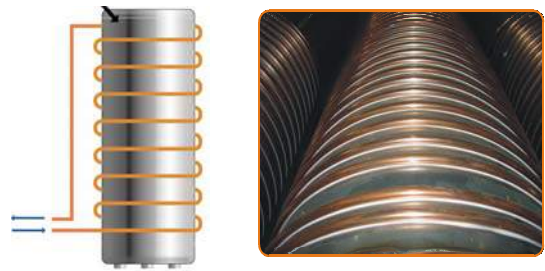

4.2 Max. outlet water Temperature: 60°C.

The system is adopted innovative heating methods: combined the Electric heating and Heat Pump heating properly, made the water be heated stably and quickly.

4.3 Flexible installation achieved by long air intake/outlet duct with pressure

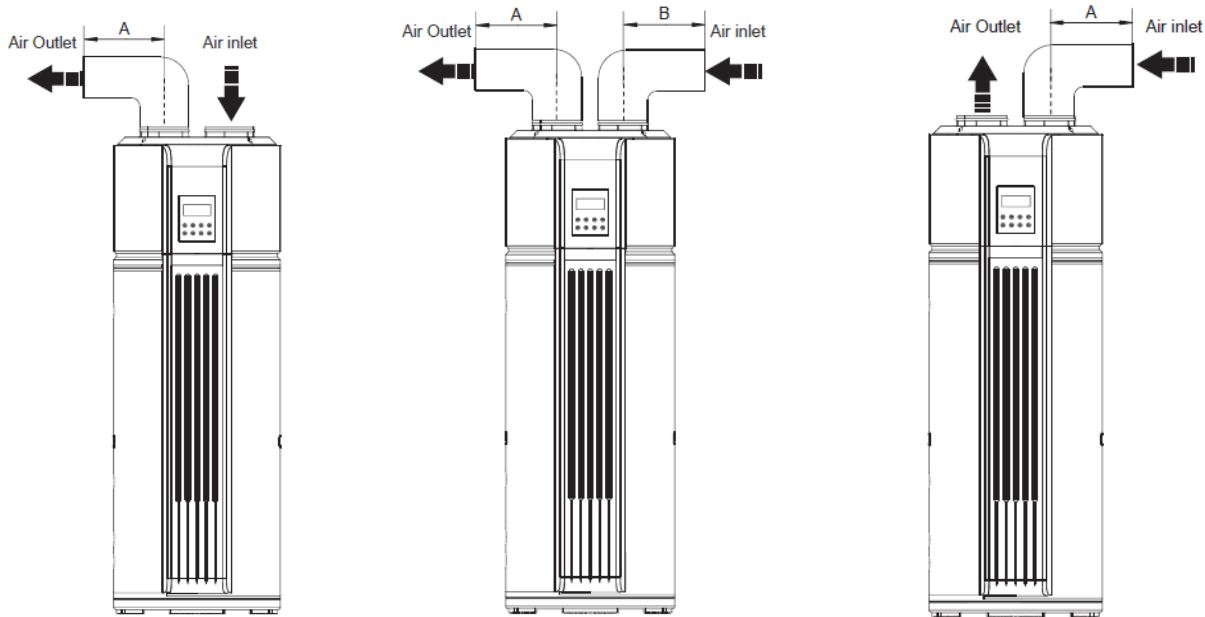

4.4 Built-in heat exchanger inside tank for integrating multiple energy, such as solar energy.

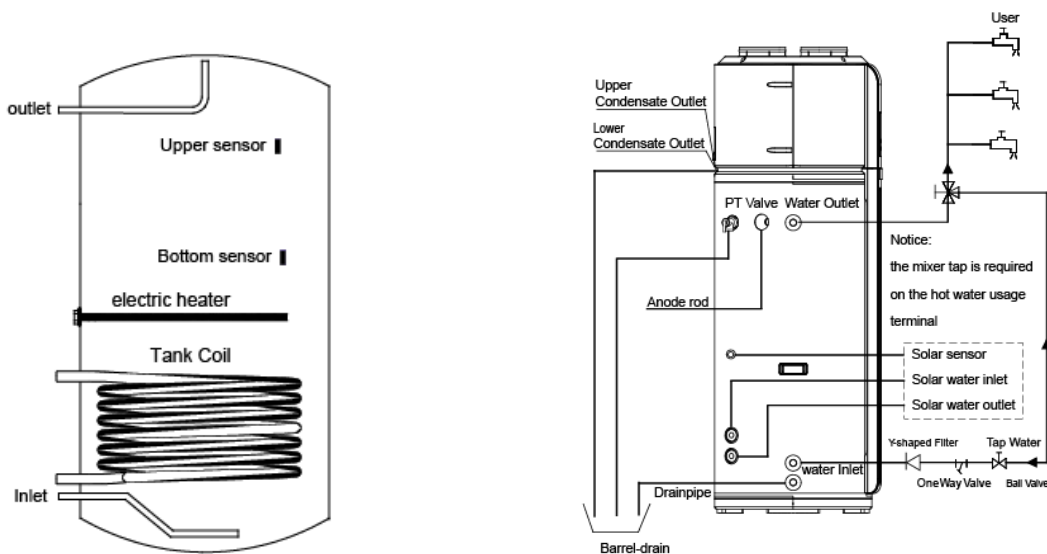

4.5 Automatic Control:

Automatic start-up and shutdown, automatic defrosting by revising refrigerant cycle. Save you much extra operation.

4.6 High Efficiency and Energy Saving.

The unit adopts heat pump principle, which absorbs heat from outdoor air and produce heat water, thermal efficiency can be approximately 3.6 (under the condition A15/12 W15/45)

4.7 All-the-weather Running.

Within the temperature range from -30 to 43°C, it will not be affected by night, cloudy sky, rain even snow whether.



Part 2

Outdoor Units

1. Specifications.....	11
2. Operation range	17
3. Capacity & COP table	17
4. Dimensions.....	17
5. Service Space.....	18
6. Wiring Diagrams	18
7. Piping Diagrams.....	20
8. Duct connection.....	17
9. Exploded View.....	22

1. Specifications

Model		RSJ-35/300RDN3-B			
Running Models		Economy	Hybrid	E-heater	
Running Ambient temp.		°C	-7~43	-30~43	
Power supply		ph-V-Hz	220~240V-1ph-50Hz		
Storage size		Ltr	300		
Water Heating Nonimal	Capacity	KW	3.00	3.00	3.00
	Input	KW	0.83	0.83	3.00
	Cop	W/W	3.60	3.60	1.00
	Rated current	A	3.00	3.00	3.00
	Testing Condition		Economy: A15/12 W15/45, setting Economy Mode; Hybrid: A15/12 W15/45, setting Hybird Mode; E-heater: A15/12 W15/45, setting E-heater Mode;		
	Max. Input	KW	1.50	4.30	3.00
	Max. Current	A	6.50	18.7	13
	Testing Condition		Economy: A 43 W60, setting Economy Mode; Hybrid: A 10 W60, setting Hybird Mode; E-heater: A15 W60, setting E-heater Mode;		
Max. Input		KW	4.3		
Max. current		A	18.7		
Starting current		A	49.0		
Compressor	Model		RB233GRDC		
	Type		Rotary		
	Brand		Guangzhou Mitsubishi electric		
	Supplier		Guangzhou Mitsubishi electric		
	Capacity	Btu/h	9500		
	Input	W	850		
	Rated current(RLA)	A	4.1		
	Locked rotor Amp(LRA)	A	30		
	Thermal protector	°C	115		
	Capacitor	uF	30		
	Crankcase	W	25		
	Refrigerant oil	ml	440 (HAB (NEO 32 or similar))		
outdoor fan motor	Model		YDK30-6R		
	Type		AC Motor		
	Brand		Welling		
	Insulation class		B		
	Safety class		IPX4		
	Input	W	68		
	Rated current	A	0.3		
	Capacitor	uF	2.5		
	Speed(hi/lo)	r/min	620/530/465		
	outdoor fan	material		ASG20	
Type			Centrifugal type		
Pressure		pa	30		
Diameter		mm	271		
Height		mm	130		
outdoor coil	Number of rows		3		
	Tube pitch(a)x row pitch(b)	mm	22*19.05		
	Fin spacing	mm	1.5		
	Fin type		Arc hydrophile seam punching fin		
	Tube outer dia.and type	mm	Φ8.0 innergroove tube		
	Coil length x height		482*352		
	Number of circuits		4		
Outdoor air flow (Hi/mid/lo)		m3/h	414/355/312		
Noise level		dB(A)	46.6		

Running Operation			Auto/Manual start up, Energy-saving, standard, Enhanced heating type heating water		
Protection Method			High-pressure protection, Over-load protection, Temp protection, Electric leakage protection		
Outdoor unit	Dimension (D*H)	mm	Φ650×1920		
	Packing (W*H*D)	mm	745*2030*775		
	Net/Gross weight	kg	113/129		
Refrigerant type/Quantity		Kg	R134a/1.2		
Design pressure (Operating pressure Refrigerant)		MPa	3.0/1.2		
Tank pressure		Mpa	0.15/0.7		
Tank Foaming Material/Depth(mm)			polyurethane/55mm		
Ambient temp		℃	-30~43		
water pipeline	Diameter, water inlet pipe	mm	DN20		
	Diameter, water outlet pipe	mm	DN20		
	Diameter, drainage pipe	mm	DN20		
	Diameter, PT valve joint	mm	DN20		
	PT valce	Brand	Watts (active condition 99℃ or 1.0Mpa)		
	Rated pressure	MPa	1.2		
	Max. Operation pressure	MPa	1.0		
	Water outlet Temp	℃	(default) 55℃, 38℃~60℃		
	Heat exchanger		Copper tube wrapped around outside of tank		
Solar heat exchanger pipeline	Diameter, water inlet pipe	mm	DN20		
	Diameter, water outlet pipe	mm	DN20		
	Heat exchanger		Surface heat exchanger; Stailless steel SUS316L		
	heat exchanger tupe Dim.*Length	mm	Φ22*10000		
	heat exchanger area	m2	0.7		
	Max.pressure	MPa	0.7		
Connection wiring	Power wiring	mm2	4		
	Signal wiring	mm2	0.75		
Fresh air	Fresh Air Diameter	mm	190.0		
	static pressure	Pa	30.0		
	Max Length	m	10.0		
Hot Water Yield		m3/h	0.075	0.075	0.064
Electric Heater		kW	3.0		

Remark:

1. The test conditions: outdoor temp. 15/12℃(DB/WB), inlet water temp. 15℃, outlet water temp. 45℃.
2. The operation range:-30℃-48℃, heat pump operation range: -7℃-43℃
3. The specification may be changed for product improvement, please refer to the nameplate.

2. Operation range

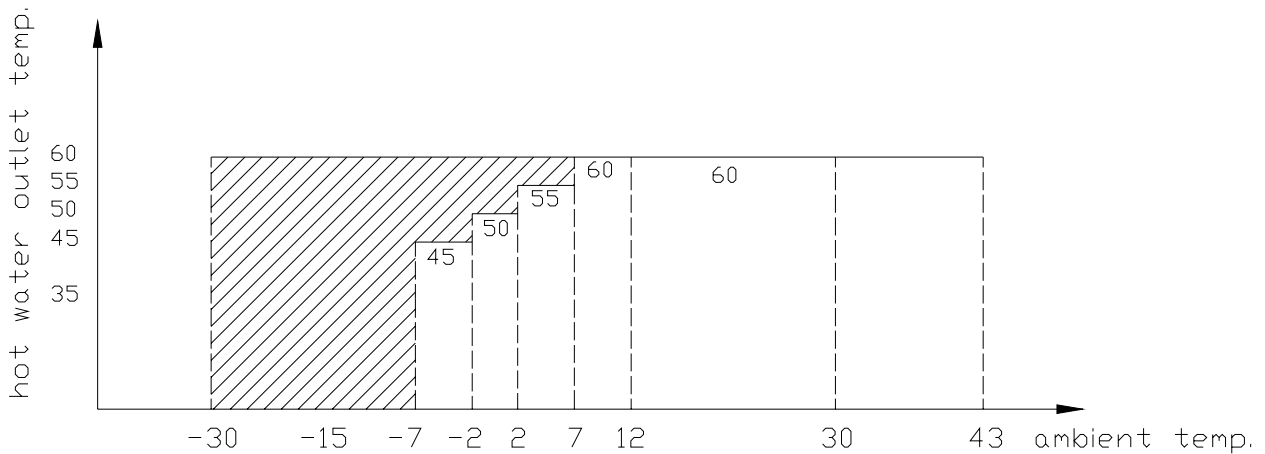

 Heated by element

 Heated by Compressor

Mode explanation: there are 3 operation MODE: ECONOMY, HYBRID and E-HEATER

ECONOMY MODE: Water firstly is heated by compressor, if can't get target temp when ambient temp. too low or too high (limitation figure is shown above), element will start as a secondary heat resource.

Hybrid mode:

E-HEATER MODE: Water is only heated by element;

ECONOMY MODE:

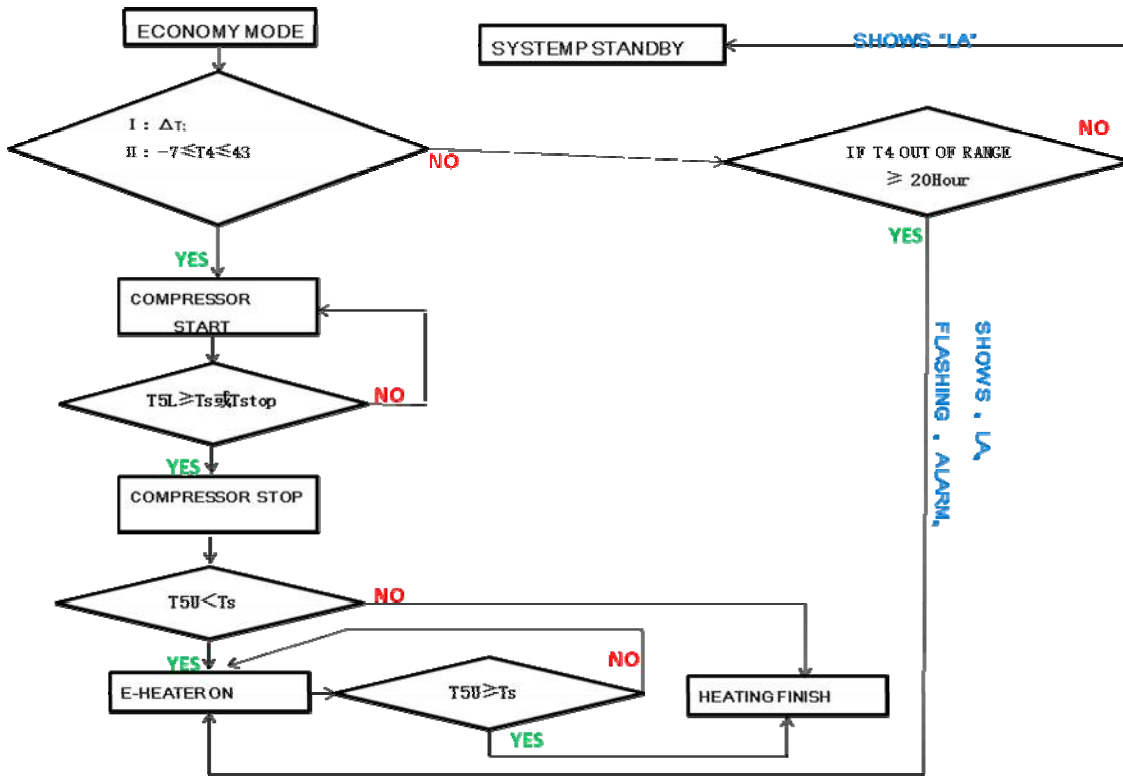

Hybrid mode:

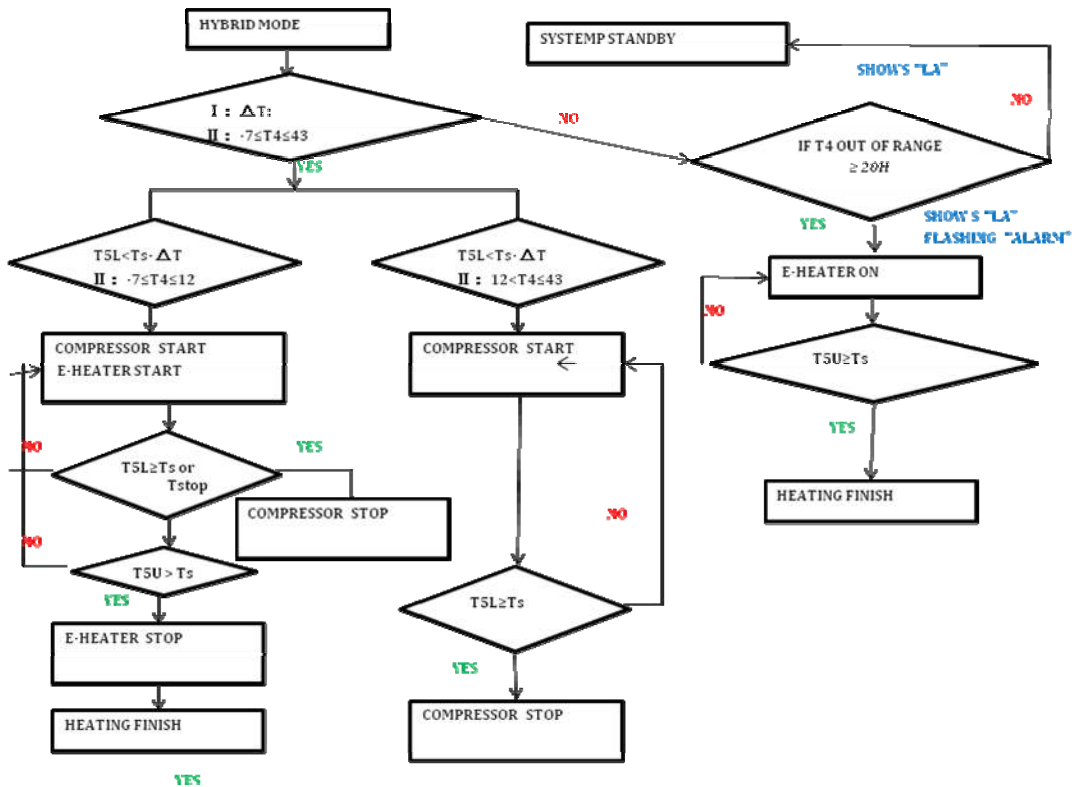

E-HEATER MODE:

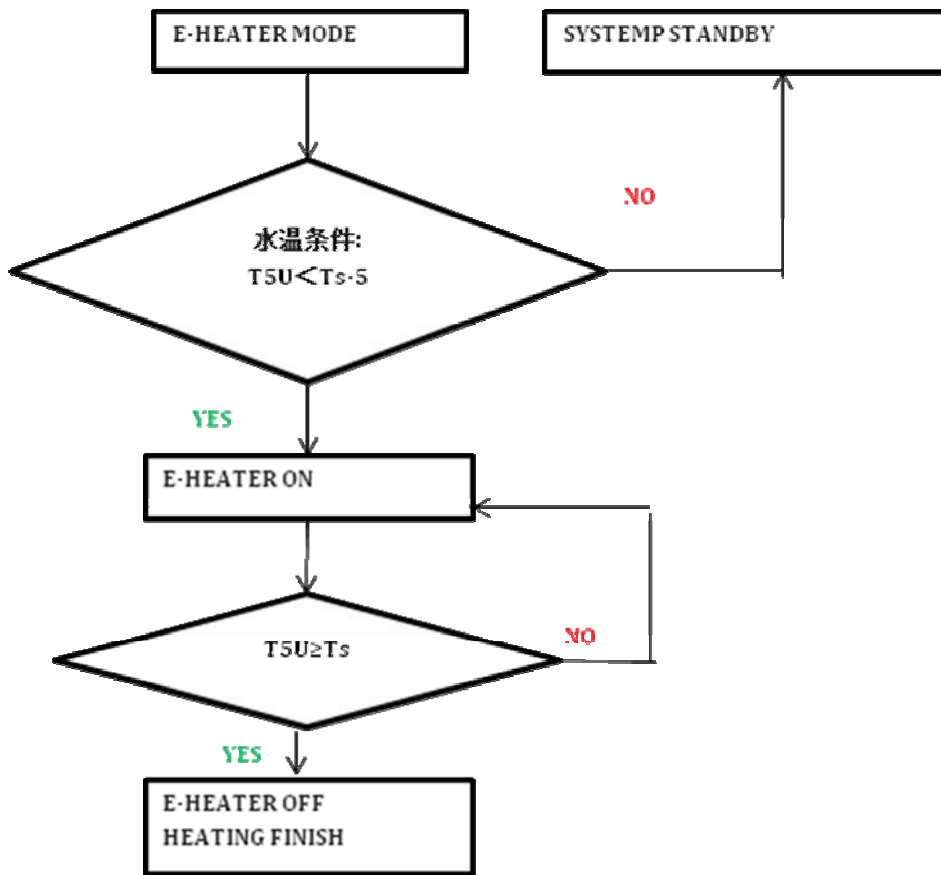

3. Capacity & COP table

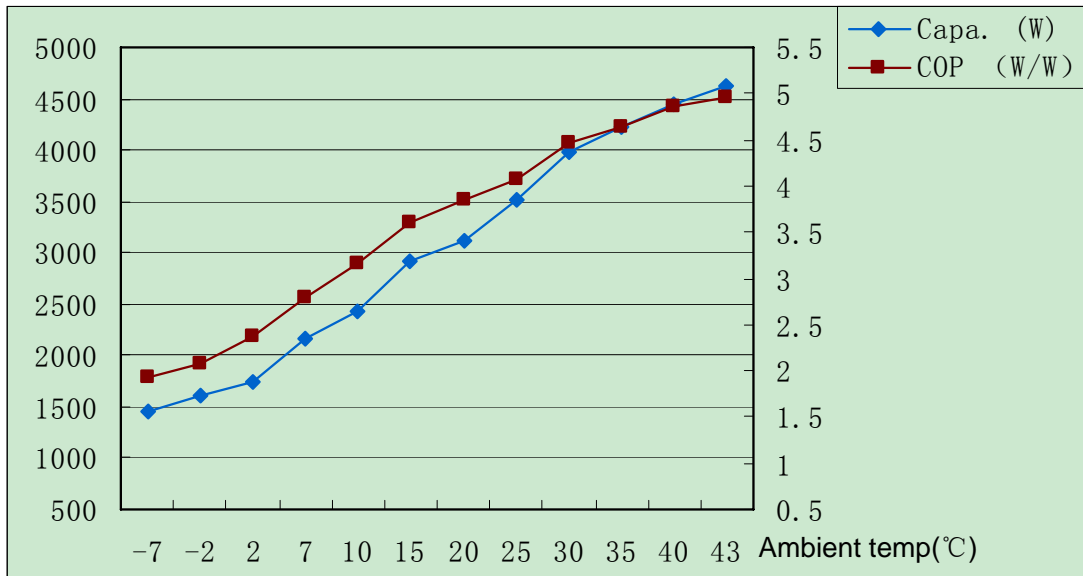

Remark:

Water inlet temp. 15°C, Water outlet temp. 45°C

4. Dimensions

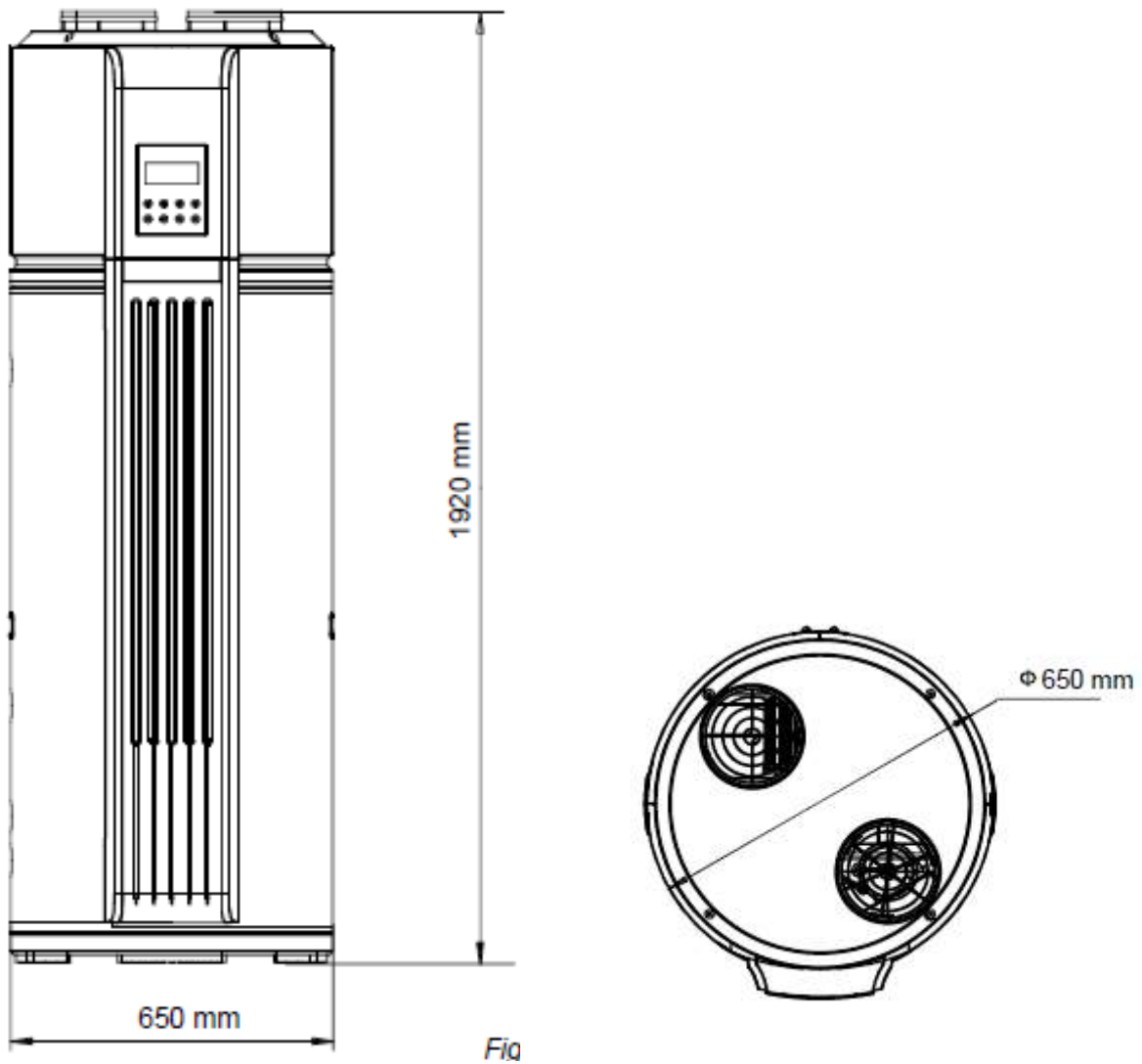

Fig

5. Service Space

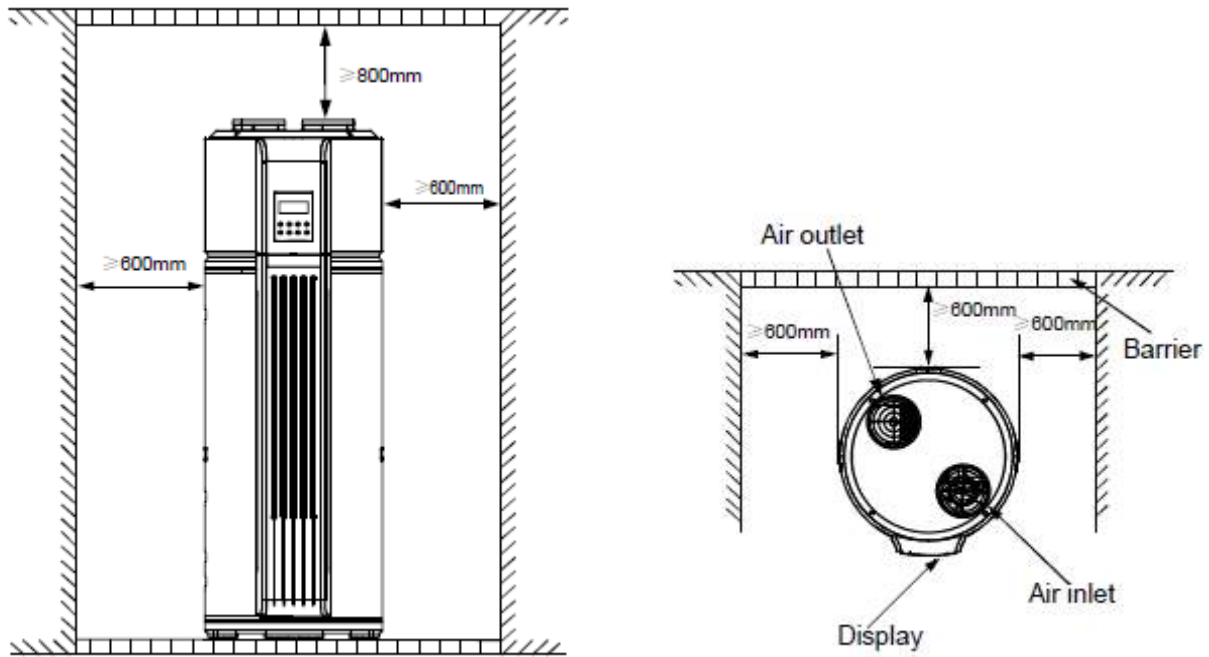

6. Wiring Diagrams

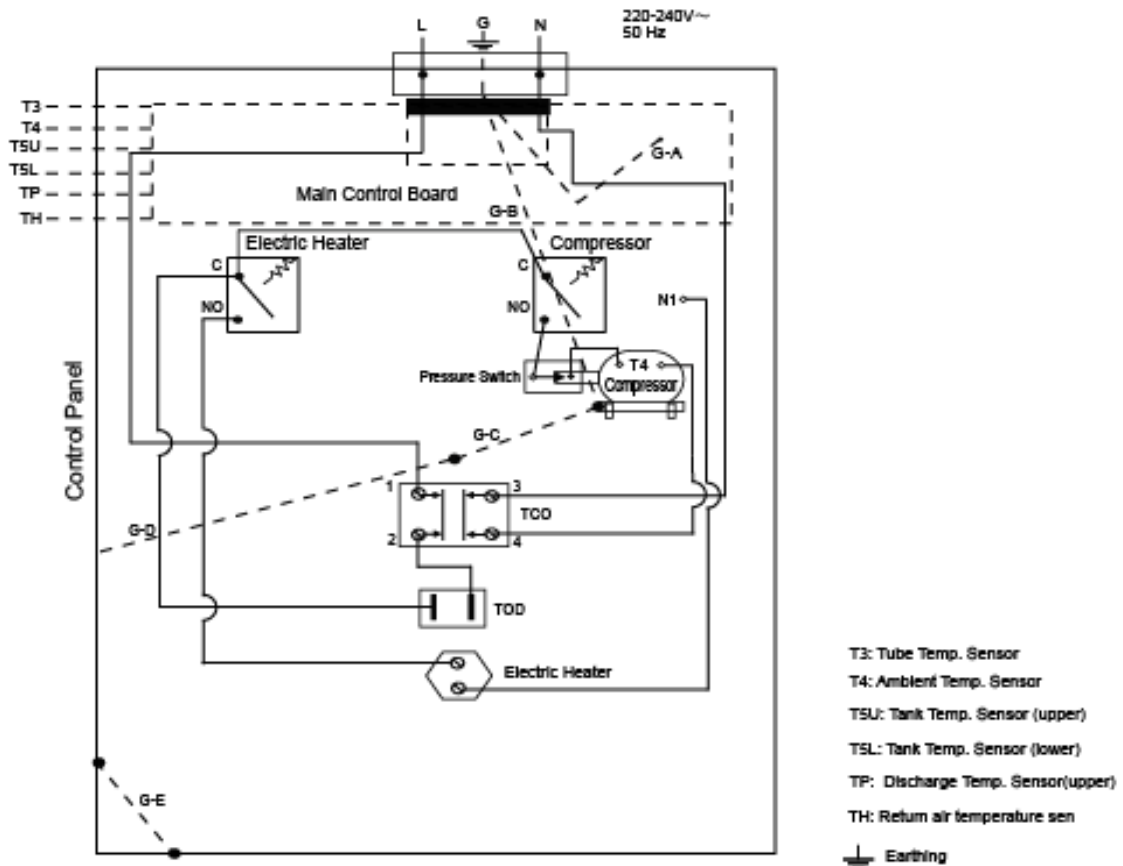

manometer (High Pressure Switch)	1	202301800820
Discharge temp sensor ass'y (Tp)	1	202301300130
room temp sensor ass'y (T4)	1	202301300196

Temp.sensor ass'y (T3)	1	202301300437
Temperature sensor (Th)	1	202301300303
senor ass'y, for the pipe (T5L)	1	202301300485
senor ass'y, for the pipe (T5Up)	1	202301300486
Relay of Elment & Compressor	2	202300800003
TCO(turn off temp. $85\pm 3^{\circ}$ C, manually recovery)	1	202301610028
TOD Auto Recovery, turn off temp. $78\pm 3^{\circ}$ C, Recovery temp $68\pm 3^{\circ}$ C.	1	202301600046

7. Piping Diagrams

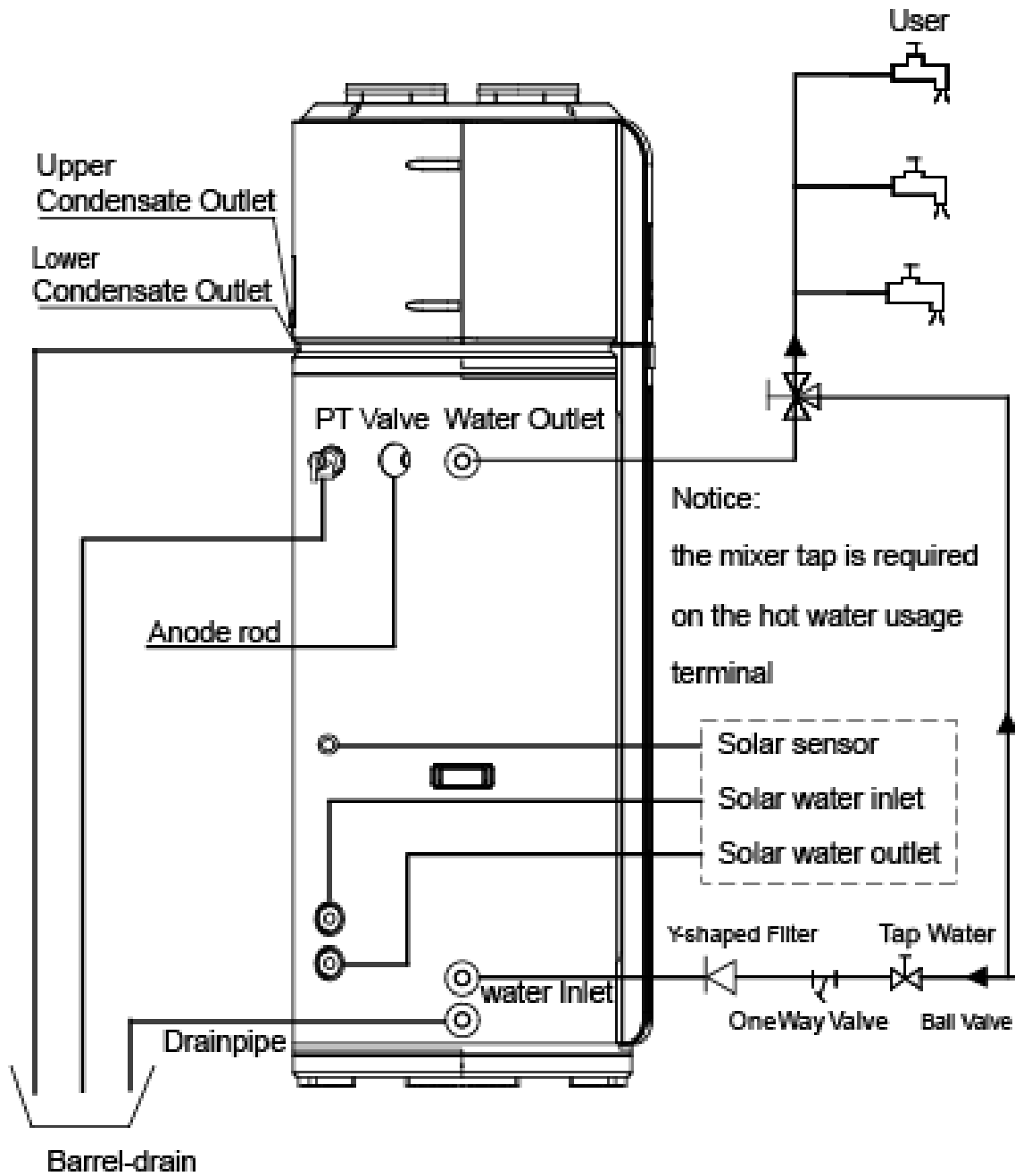

8. Duct connection

A: Air inlet & outlet without canvas

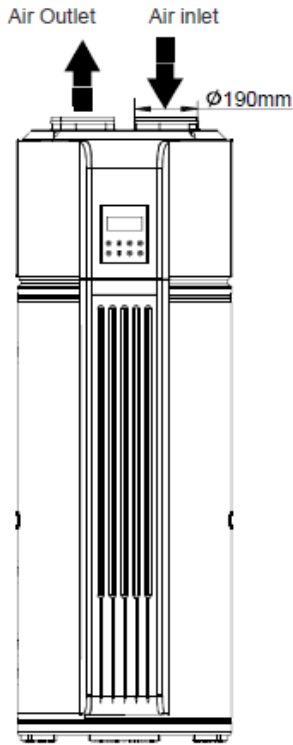

B: Only air outlet with canvas, $A \leq 10\text{m}$

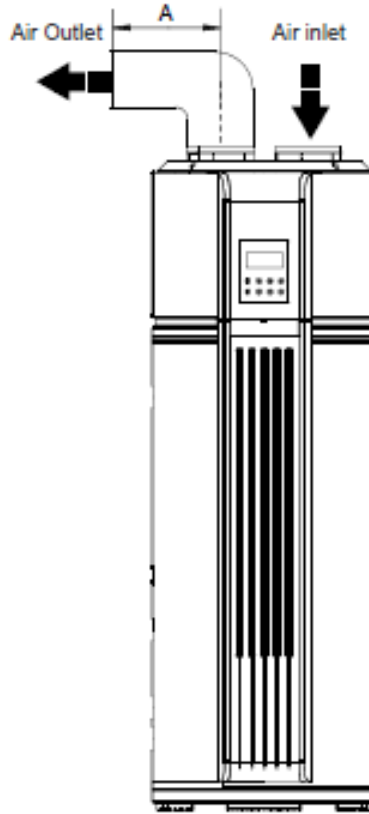

When there is stable heat source in room in winter

C: Air inlet & outlet with canvas, $A+B \leq 10\text{m}$

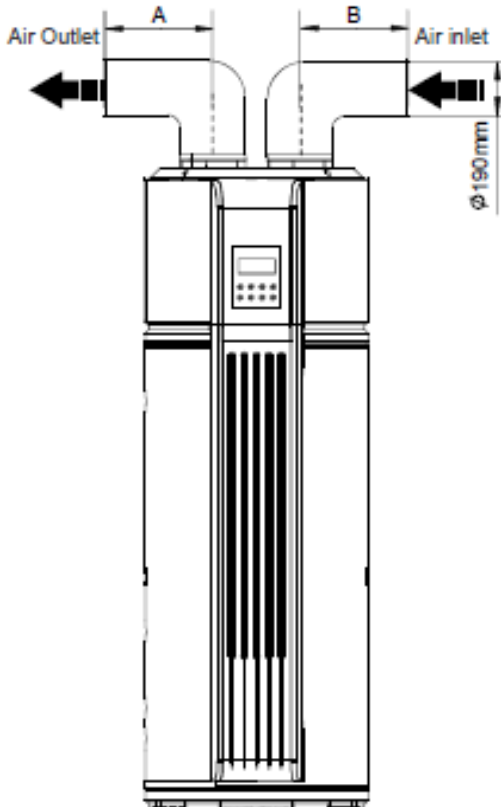

D: Only air inlet with canvas $A \leq 10\text{m}$

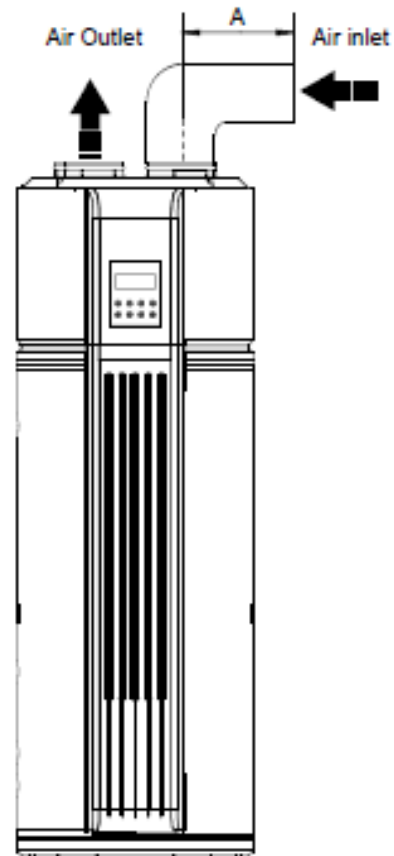

Charge fresh air from ambient in summer

9. Exploded View

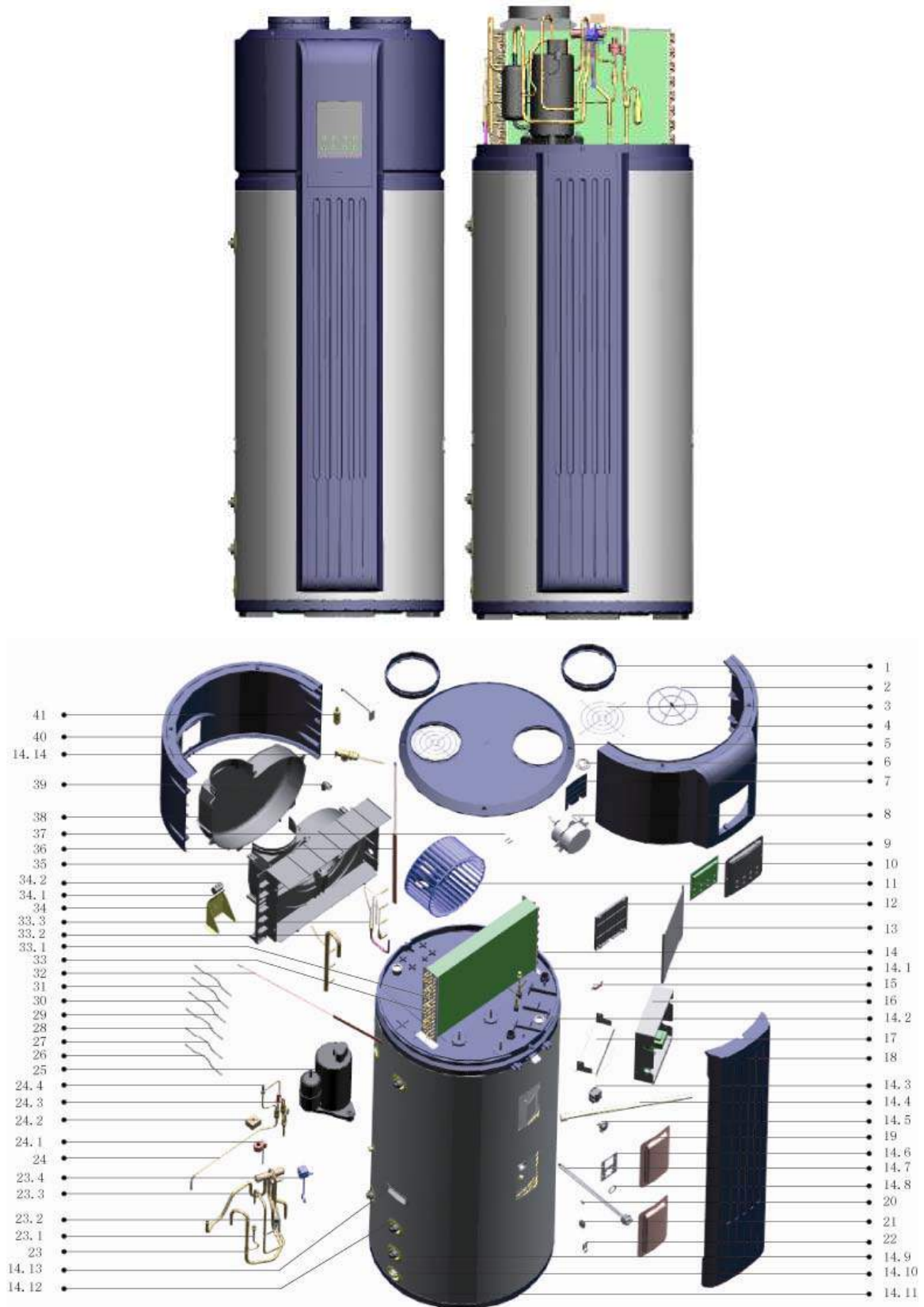

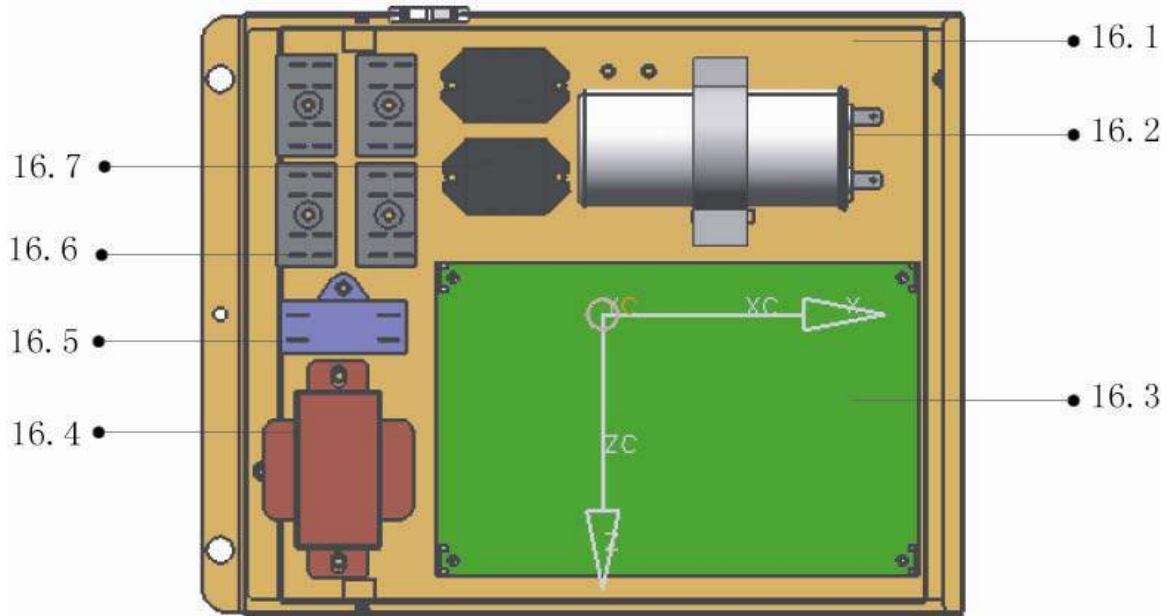

No.	Part Name	Quantity	No.	Part Name
1	Airout ring	2	18	Decorating board
2	Air filter	1	19	Cover, upper heating element
3	Filter	2	20	Deck magnet
4	Plastic cowling	1	21	Magnet clip
5	Top	1	22	Magnet cover
6	Magnesium stick plug	1	23	Four-way valve
7	Cover, wire-connceting box	1	23.1	Pipe joint
8	Asynchronism motor	1	23.2	Manometer (High Pressure Switch)
9	Display board	1	23.3	4-way valve
10	Display board ass'y	1	23.4	Solenoid
11	Centrifugal fan	1	24	Electronic Expansion Valve ass'y
12	Cover, display	1	24.1	EEV solenoid
13	Electric control box	1	24.2	Solenoid valve winding
14	Forming	1	24.3	Electronic Expansion Valve
14.1	Forming plug	1	24.4	Solenoid valve
14.2	Froth plug	2	25	Compressor
14.3	TCO(turn off temp. $85 \pm 3^{\circ}$ C, manually recovery)	1	26	Discharge temp sensor ass'y (Tp)
14.4	Magnesium stick	1	27	Room temp sensor ass'y (T4)
14.5	TOD Auto Recovery, turn off temp. $78 \pm 3^{\circ}$ C, Recovery temp $68 \pm 3^{\circ}$ C.	1	28	Temp. sensor ass'y (T3)
14.6	Stator of temp. sensor	1	29	Temperature sensor (Th)
14.7	Heating element	1	30	Senor ass'y, for the pipe (T5L)
14.8	Sealed ring	1	31	Senor ass'y, for the pipe (T5Up)
14.9	Seal Stopper	4	32	Compressor electric heater
14.10	Drain stop up	1	33	Evaporator ass'y
14.11	Lower cover, for the tank	1	33.1	Evaporator
14.12	PT velve loop	7	33.2	Evaporator output pipe ass'y
14.13	Handle for the tank	2	33.3	Evaporator input pipe ass'y
14.14	PT valve	1	34	Wire connecting box
15	Magnetic holder	1	34.1	Holder

16	Electric control board ass'y	1	34.2	Wire joint, 3p
16.1	Electric control board jointing	1	35	Front snail shell
16.2	Compressor capacitor	1	36	Compressor connector
16.3	Main control board ass'y	1	37	Platen
16.4	Transformer for power supply	1	38	Back snail shell
16.5	Motor capacitor	1	39	Drainage bend
16.6	Wire joint	4	40	Upper plastic cowling
16.7	Relay of Elment & Compressor	2	41	Filter
17	Holder for electric control board ass'y	1		

Part 3

Installation

1. Precautions	26
2. Installation information	27
3. Unit Appearance and Composition	28
4. Accessories	29
5. Inspecting and Handling the Unit.....	29
6. Electric Wiring.....	29

1. Precautions

To prevent injury to the user or other people and property damage, the following instructions must be followed. Incorrect operation due to ignoring of instructions may cause harm or damage.

The safety precautions listed here are divided into two categories. In either case, important safety instructions are listed to which close attention must be paid.

WARNING

Failure to observe a warning may result in death.

CAUTION

Failure to observe a caution may result in injury or damage to the equipment.

WARNING

- The water heating unit must be earthed effectively.
- A creepage breaker must be installed near the power supply.
- Ask your supplier for installation of the air source heat pump water heating units. Incomplete installation performed by yourself may result in water leakage, electric shock, or fire.
- Ask your supplier for the repair and maintenance. Incomplete repair and maintenance may result in water leakage, electric shock or fire.
- In order to avoid electric shock, fire or injury, if any abnormality is detected, such as smell of fire, turn off the power supply and call your supplier for instructions.
- Never replace a fuse with that of wrong rated current or other wires when a fuse blows out. Use of wrong wire or copper wire may cause the unit to break down or a fire.
- Do not insert fingers, rods or other objects into the air inlet or outlet. When the fan is rotating at high speed, it will cause injury.
- Never use a flammable spray such as hair spray, lacquer paint near the unit. It may cause a fire.
- Never touch the air outlet or the horizontal blades while the swing flap is in operation. Fingers may become caught or the unit may break down.
- Never put any objects into the air inlet or outlet. Objects touching the fan of high speed can be dangerous.
- Do not dispose this product as unsorted municipal waste. Collection of such waste separately for special treatment is necessary.
- The appliance shall be installed in accordance with national wiring regulations.

CAUTION

- The ground pole of socket must be grounded, and the rated current should be more than 10A. Make sure that socket and attaching plug are dry always and have a good connection.
Method: Turn on power supply, run the unit for half a hour, then turn it off and check if the attaching plug is hard. If it's hard (more than 50°C), please change it with a new and eligible one, or it may result in an electric shock or fire.
- Do not use the air-source water heater for other purposes.
- Before cleaning, be sure to stop the operation and turn the breaker off or pull out the power cord. Otherwise, an electric shock and injury may be caused.
- In order to avoid injury, do not remove the fan guard on the outdoor unit.
- Do not operate the air-source water heater with a wet hand. An electric shock may be caused.
- In the place and the wall where water may be spattered, the installation height must be more than 1.8m.
- At the water inlet, the One Way valve must be installed.

- It's normal if some water drips from the hole of PT valve in operation. But, if the water is in a great amount, call your supplier for instructions.
- After a long use, check the unit stand and fittings. If damaged, the unit may fall and result in injury.
- Arrange the drain hose to ensure smooth drainpipe. Incomplete drainpipe may cause wetting of the building, furniture etc.
- Never touch the internal parts of the controller.
- Do not remove the front panel. Some parts inside are dangerous to touch, and a machine malfunction may be caused.
- Never expose babies, plants or animals directly to the air flow. Adverse influence to babies, animals and plants may be resulted.

2. Installation information

- Enough space is installation and maintenance shall be preserved.
- The air inlet and outlet should be free from obstacles and strong wind.
- The bearing surface should be flat, able to bear weight of the unit and suitable for installing the unit horizontally without increasing noise or vibration.
- The operation noise and air flow expelled shall not affect neighbors.
- No flammable gas is leaked nearby.
- It is convenient for piping and wiring.

CAUTION

- Installing the equipment in any of the following places may lead to malfunction of the equipment (if it is inevitable, consult the supplier):
 - 1) The site contains mineral oils such as cutting lubricant.
 - 2) Seaside where the air contains much salt.
 - 3) Hot spring area where corrosive gases exist, e.g., sulfide gas.
 - 4) Factories where the power voltage fluctuates seriously.
 - 5) Inside a car or cabin.
 - 6) Place like kitchen where oil permeates.
 - 7) Place where strong electromagnetic waves exist.
 - 8) Place where flammable gases or materials exist.
 - 9) Place where acid or alkali gases evaporate.
 - 10) Other special environments.
- Precautions before installation
 - 1) Decide the correct way of conveying the equipment.
 - 2) Try to transport this equipment with the original package.
 - 3) If the unit has to be installed on a metal part of the building, electric insulation must be installed, and the installation must meet the relevant technical standards for electric devices.

- Installation space

Before installing the unit, reserve the space of maintenance .

WARNING

- Ask your supplier to install the air source heat pump water heating units. Incomplete installation performed by yourself may result in a water leakage, electric shock, or fire.
- The place without direct sunlight and other heat supplies. If there's no way to avoid these, please install a covering.

- The unit must be securely fixed, or else, noise and shaking will be resulted.
 - Make sure that there's no remora around the unit.
 - In the place where there is strong wind like seashore, fix the unit in the location protected from the wind.
 - Carry the unit onto the site
- 1) In order to avoid scratch or deformation of the unit surface, apply guard boards to the contacting surface.
 - 2) No contact of fingers and other things with the vanes.
 - 3) Don't incline the unit more than 45° in moving, and keep it vertical when installing.
- Install the unit.
- 1) The circulating air for every unit should be more than 700m³/h.
 - 2) Make sure there is enough Installation space.
 - 3) Outline dimensional drawing

3. Unit Appearance and Composition

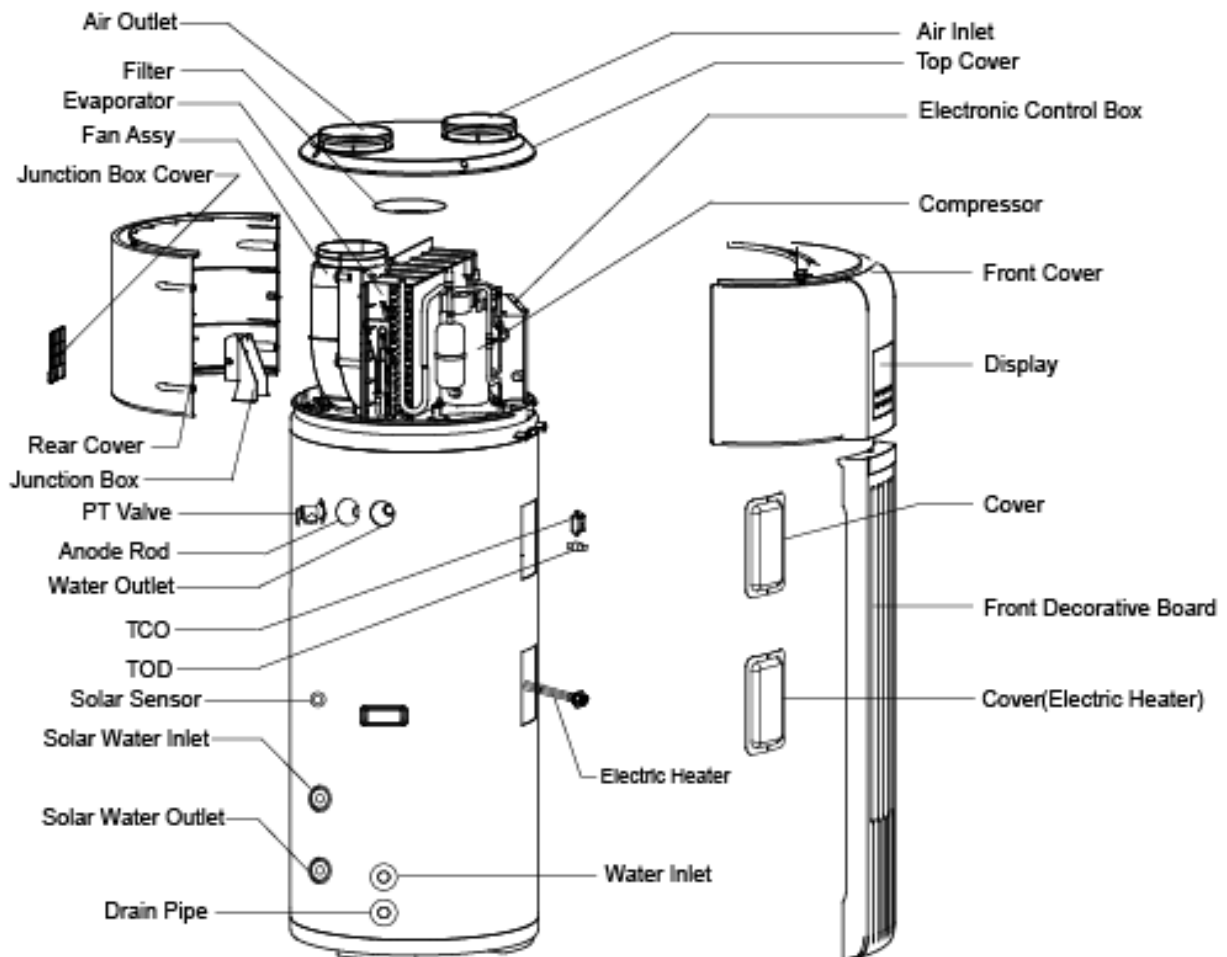

4. Accessories



Check whether the following assemblies are complete.

Name	Quantity	Note	Purpose
Installation & Operation Manual	1	—	Installation and Operation instruction
Y-sharp Filter	1	—	Inlet water filter
Drain Pipe for Condensate water	2	—	For condensed water discharge use
One Way Valve	1	—	To prevent water from flowing back
Wired Controller (optional)	—	—	To control and monitor the unit status

5. Inspecting and Handling the Unit

After delivery, the package should be checked and any damage should be reported immediately to the carrier claims agent.

When handling the unit, take into account the following:

-  Fragile, handle the unit with care.
-  Keep the unit upright in order to avoid compressor damage.
- Choose before hand the path along which the unit is to be brought in.
- Move this unit with original package.
- When lifting the unit, always use protectors to prevent belt damage and pay attention to the balance of the unit's gravity.

6. Electric Wiring

6.1 Attention

- The water heater should be powered separately and the power voltage should be in line with rated voltage..
- The power supply circuit of the water heater should be earthed, the power cord should be connected with the external earthing line in reliable state and all the external earthing cables are effective.
- The construction of the wiring should be carried out by professionals in accordance with the circuit diagram.
- Set up leakage protection devices in accordance with the requirements of the relevant national technical standards.
- The power cord and the signal line should be laid neatly without cross-interfere and should not contact with the connecting pipe and the valves.
- The unit is not equipped with power cord. Please refer to the prescribed power specification for selecting the power cord and cross-connection between two lines are not allowed.
- Check whether all the connections are correct before powering the unit.

6.2 Power specification

Model Name	RSJ-35/300RDN3-B
Power Supply	220-240V~50Hz
Min. Diameter of Power Supply Line(mm ²)	4
Earth wire(mm ²)	2.1
Manual Switch(A) Capacity/Fuse	15/5
Creepage Breaker	30 mA ≤ 0.1sec

6.3 Power Supply Wiring .

A. Power Supply Schematic Diagram

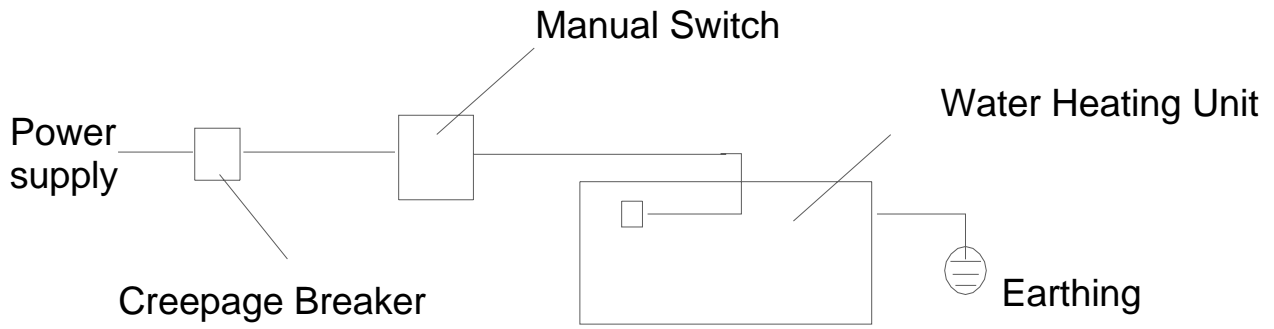

Warning:

Although there is a leakage protector in the electric control box of the unit, for the security reason, it is required that a leakage protection equipped cable and Earthing should be applied for the unit according to the requirement on the above diagram.

B. Cable Diameter Selection

The power supply wiring refers to the wiring to the main line (a) of junction box and the wiring (b) to the power supply equipment. Please select the cable diameter according to the following methods

1) Diameter of the main line (a):

Get from the power supply specification table according to the sum of horsepower of the unit.

2) Diameter of the wiring from the junction box to the power supply equipment:

When the water heaters are less than 5 sets, the diameter the wiring from the junction box to the power supply equipment should be the same as the main line (a); when the water heaters are more than 6 sets, the power supply equipment should have two sets of electric control box and the diameter should be get from the power supply specification table according to the sum of horsepower of the units connected by the electric control box.

Part 4

Trial Operation

1. Confirmation Before the Trial Operation	327
2. Operating Instruction	32
3. PCB explanation	51
4. Maintenance	51
5. Malfunctions and Resolutions.....	53

1. Confirmation Before the Trial Operation

- 1.1 All the installation is complete.
- 1.2 Water heater is installed correctly.
- 1.3 The pipelines and wiring are correct.
- 1.4 The accessories are installed correctly.
- 1.5 The drainage is smooth.
- 1.6 The thermal insulation is sound.
- 1.7 The earthing wire is connected correctly.
- 1.8 The power voltage is consistent with the rated voltage of the heater.
- 1.9 No obstacle at the air inlet and outlet of the unit.
- 1.10 The leakage protector can work effectively.

2. Operating Instruction

2.1 Instruction

2.1.1 Before using this unit, please follow the steps below.

Water Affusion: If the unit is used for the first time or used again after emptying the tank, please make sure that the tank is full of water before turning on the power. Method: see figure 2.1.1

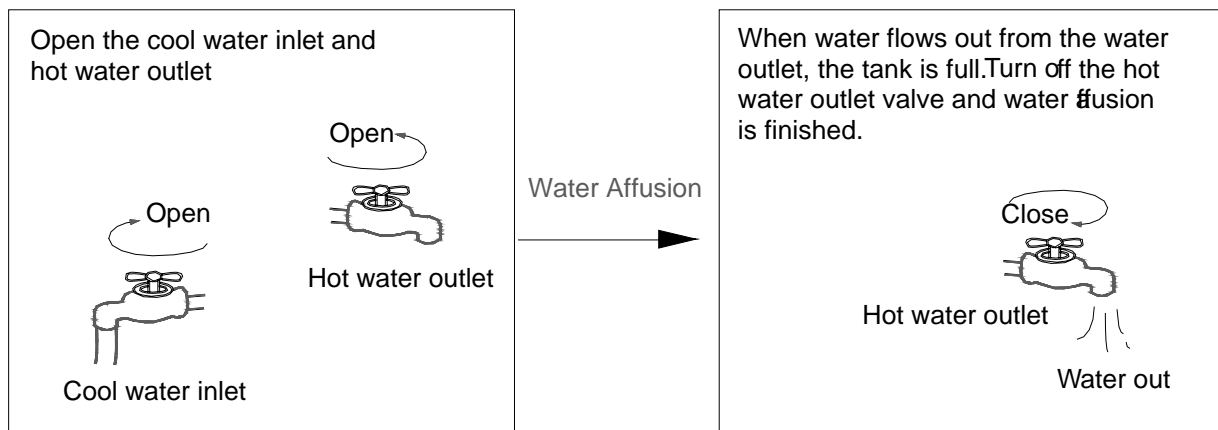

NOTE:

- 1. The Ball Valve at water inlet should be open when the unit is in operation.
- 2. Operation without water in water tank may result in damage of auxiliary e-heater. Due to such damage, the supplier is not responsible for the quality issue.

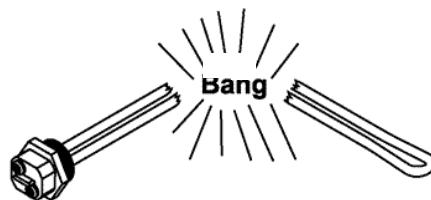

- 3. Over 50°C may result in serious burn or so caused death. Special care should be paid to the children, the disabled and the old in case of water burn.

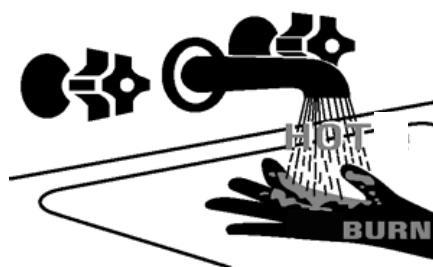

2.1.2 After powered on, the display lights up. Users can operate the unit through the buttons under the display for different modes. Emptying: If the unit needs cleaning, moving etc, the tank should be emptied. Method: See Figure 2.1.2

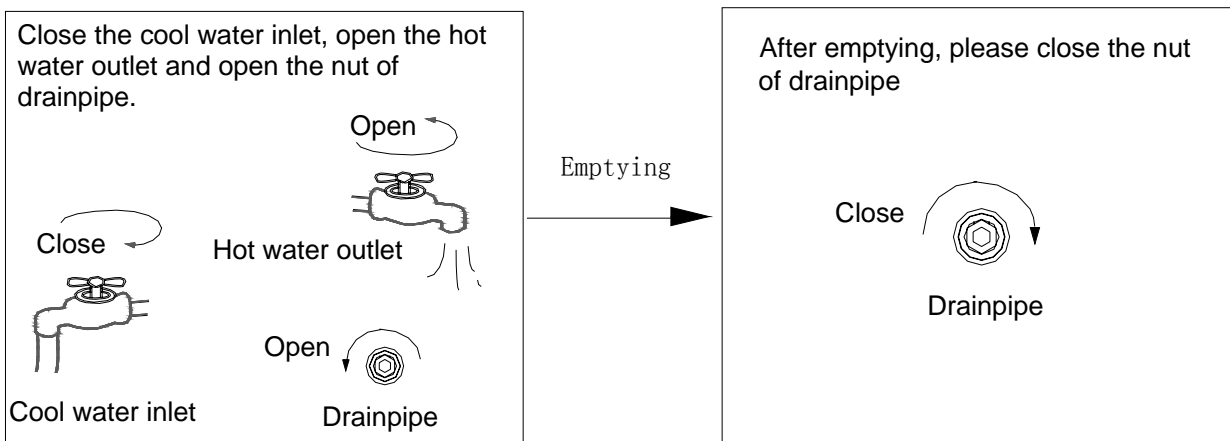

NOTE: The outlet water temp. may be very high when emptying, beware of your body for burns.

2.2 Operation

2.2.1 Control Panel Explanation

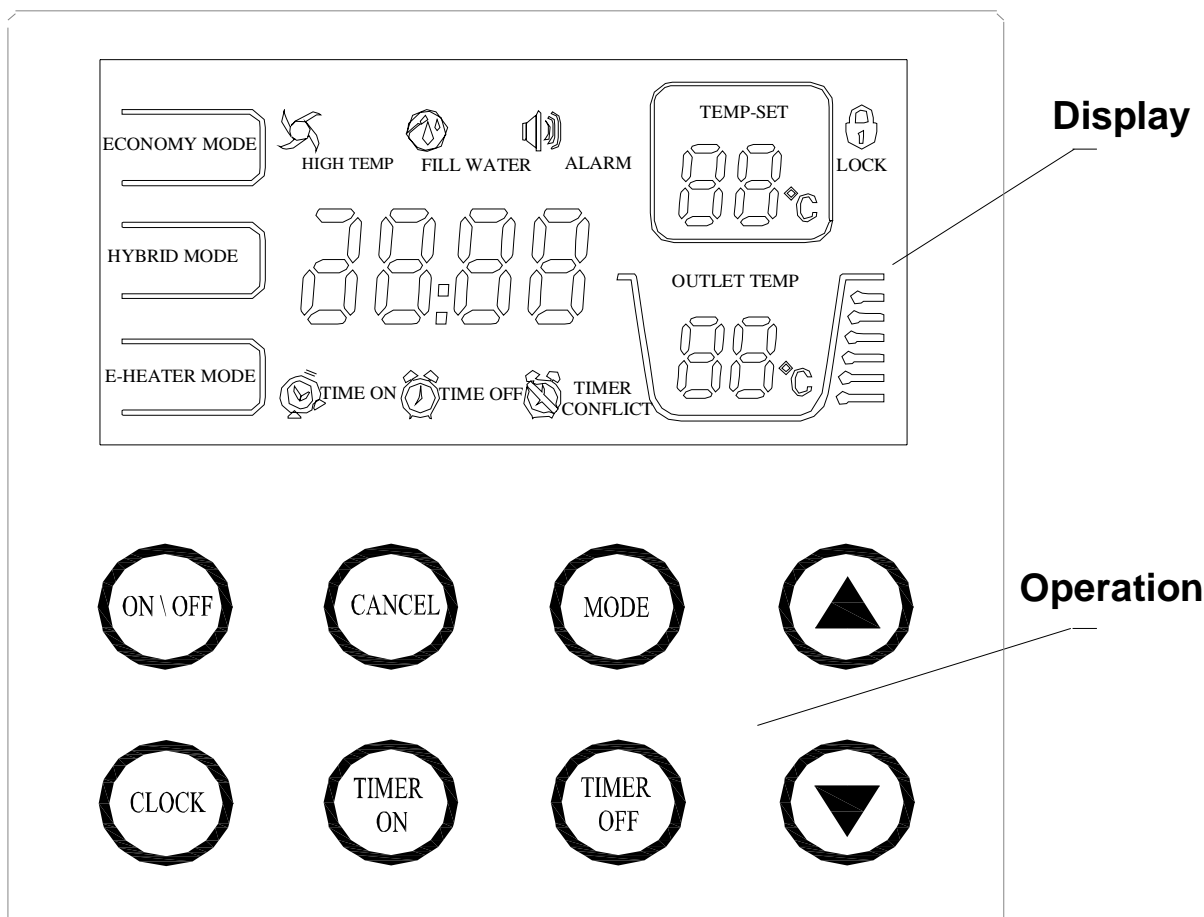

2.2.2 Display Explanation

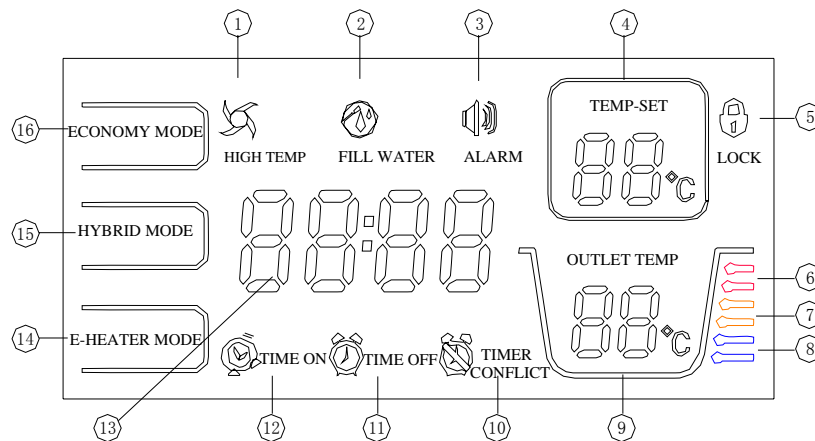

Number	Explanation	Number	Explanation
1	HIGH TEMP indicator. When the setting temp. exceeds 50°C, it lights up to remind you that the outlet temp. is too high for direct spray.	9	OUTLET TEMP indicator. It displays water temp. of the upper part of the tank, which can be used. It always lights.
2	FILL WATER indicator. When the power supply is turned on, it lights up to remind you to re-affuse water.	10	TIMER CONFLICT indicator. When the temp you set through Wired Controller conflicts with that through User Interface, it lights up.
3	ALARM indicator: It will flashing at the malfunction or protection time.	11	TIME OFF indicator: It will light up when timing off mode is set, blanks when screen protection.et, blanks when screen protection.
4	TEMP-SET indicator: Show the setting temperature and blank when screen protection. Codes are show at the malfunction or protection time	12	TIME ON indicator: It will light up when timing on mode is set, blanks when screen protection.et, blanks when screen protection.
5	LOCK indicator. When the UI is locked, it always lights.	13	CLOCK indicator. It displays present time, it will blanks when screen protection
6	Water temp. indicator. When the actual water temp. exceeds 60°C, it lights up.	14	E-HEATER MODE indicator. When user sets the E-heating Mode, it lights up.
7	Water temp. indicator. When the actual water temp.exceeds 50°C, it lights up.	15	HYBRID MODE indicator. When user sets the Hybrid Mode, it lights up.
8	Water temp. indicator. When the actual water temp. exceeds 40°C it lights up.	16	ECONOMY MODE indicator. When user set the Economy Mode, it lights up.

2.2.3 Operation

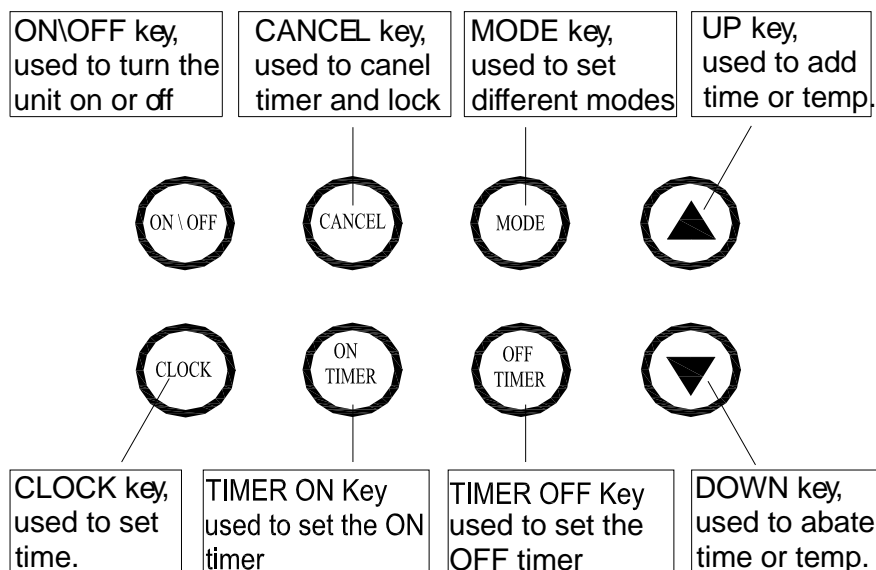

2.2.4 Operation Instruction

2.2.4.1 Preparation before running the unit.

- a) When you run the unit for the first time, all the indicators on the UI will light for 3 second, and the buzzer will “didi” ring twice at the same time, and then, display the fiducially web page. After no operation for 1 minute, all indicators will go out automatically except Water fill indicator flashing and Clock indicator lighting. Buzzer will “di” ring when you press it.
- b) When the tank is full, please press the ON\OFF key, the Water fill indicator will stop flashing and you can continue to function other settings. When all settings finished, please press the ON\OFF key again and the Water fill indicator will go out. And then run the unit.
- c) When the unit is running, if there is no operation or malfunction for 20s, the backlight of the display will go out automatically except Clock indicator and Water fill indicator. If there no operation for 1min, the unit will lock automatically, but the lock indicator would be right all time.

2.2.4.2 Lock and Unlock

In order to prevent wrong operation, a special lock function has been designed. If there is no operation for 1min, the unit will be locked automatically, and display the lock sign (Lock indicator lights up).When the unit is locked, no keys can be operated.

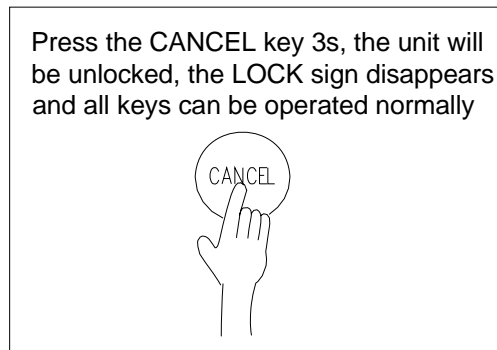

2.2.4.3 Clock Setting

The clock is for a 24-hour system and the initial time is 00:00. To make a better use of this unit, it is recommended to set the time for accurate local time. Every time powered off, the clock will be reset to the initial time 00:00.Method for time set

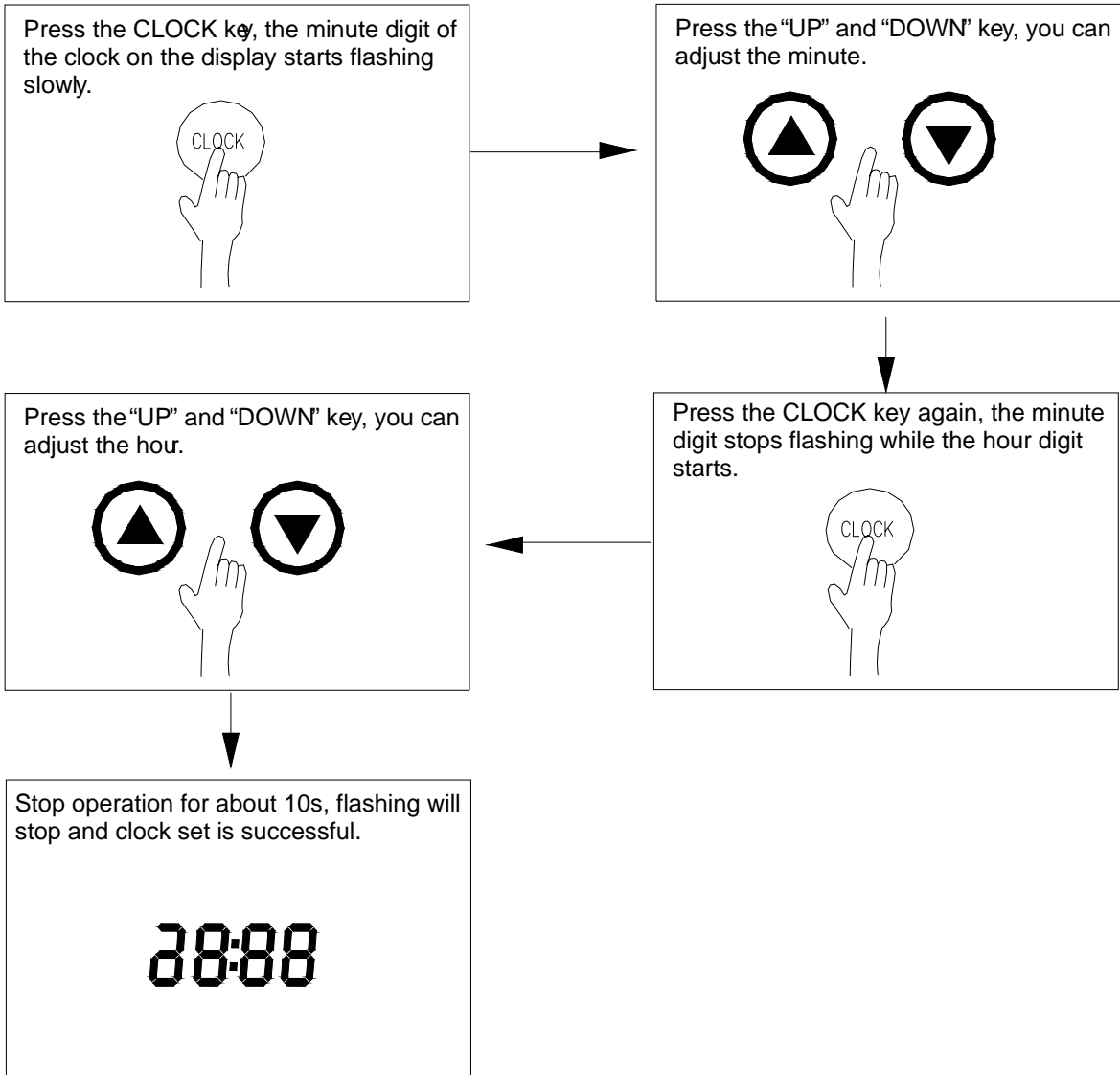

2.2.4.4 Mode Selection

- a) The unit is enhanced with three operation modes, Economy Mode, Hybrid Mode and E-heater Mode.
- b) Economy Mode: The unit heats water only by compressor drive according to heat-pump principle. Used when the ambient temp. is high.
- c) Hybrid Mode: The unit heats water not only by compressor drive but also by electric heater. Used when the ambient temp. is low or large amount of hot water is needed.
- d) E-heater Mode: The unit heats water only by electric heater. Used when the ambient temp. is very low.
- e) By default, the unit operates in Hybrid Mode.

Change:

Press the MODE key, operation mode will be shifted among the three modes in a cycle, meanwhile the corresponding indicator on the display will light up.



2.2.4.5 Temperature Setting

Temp displayed is the water temp. in the upper part of the tank. Default is 55°C and the setting range is 38~60°C.

Method for set.

Press the "UP" and "DOWN" key, you can increase and decrease the water temp setting.

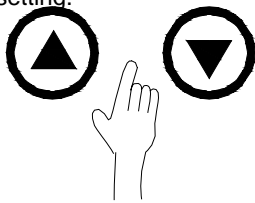

When the setting temp is higher than 50°C the Temp Operation High indicator will light

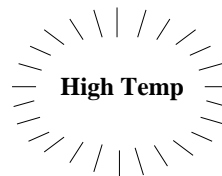

2.2.4.6 TIMER

User can set up a running start time and a stop time on a specifically by the timer function. The least numbers of timer is ten minutes. Time on: User can set up a start time by this. The unit will auto run one time between the set time and 24:00 on the same day.

Method for set.

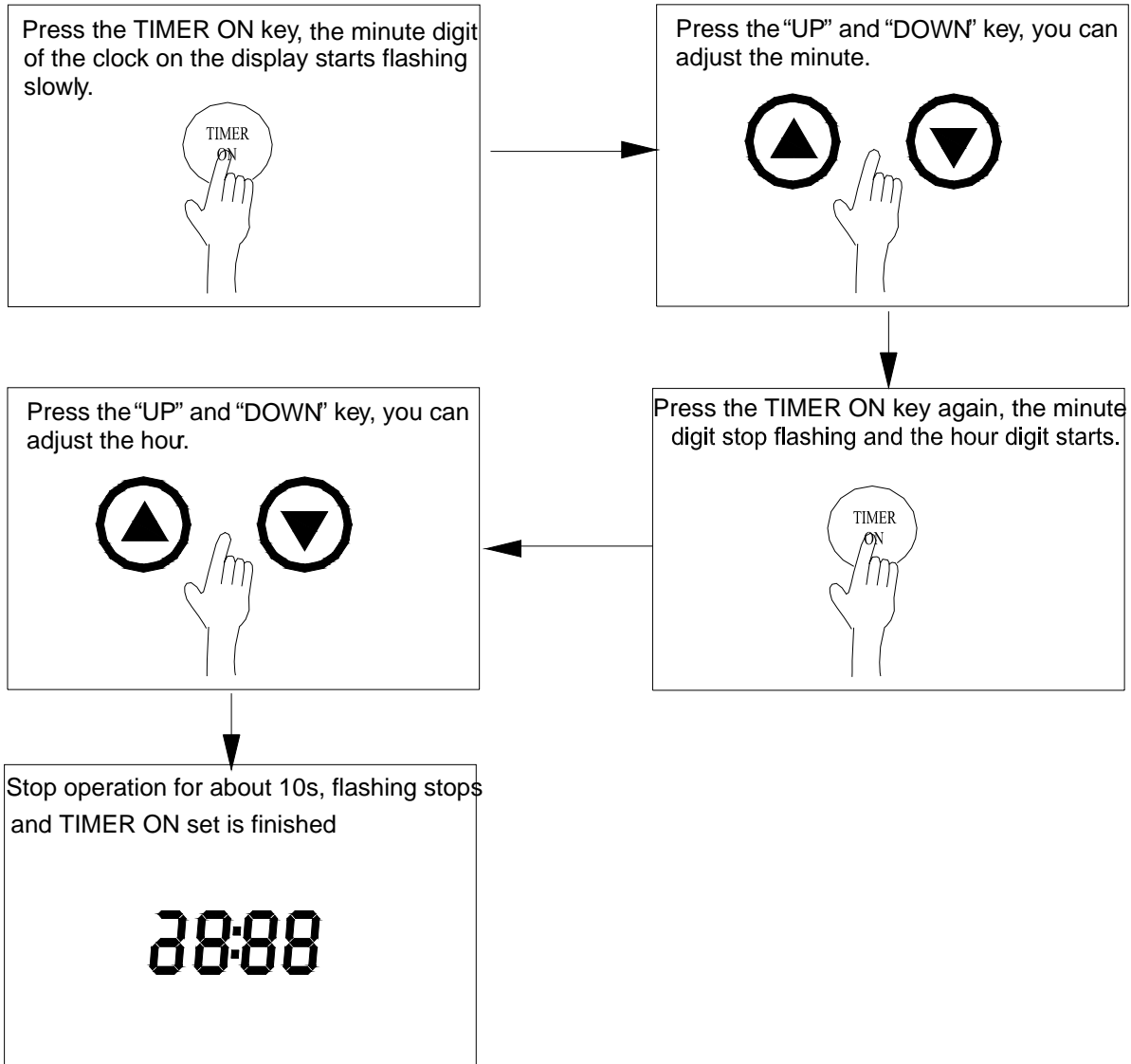

CANCEL:

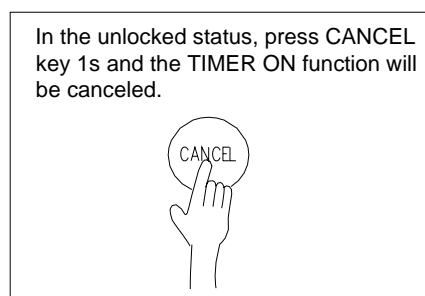

2.2.4.7 **TIMER ON and TIMER OFF:** Users can set up a running start time and a stop time. When the start time is earlier than the stop time, the unit will run between the set time. When the start time is later than the stop time, the unit will run between the start time today and the stop time next day.

Method for set.

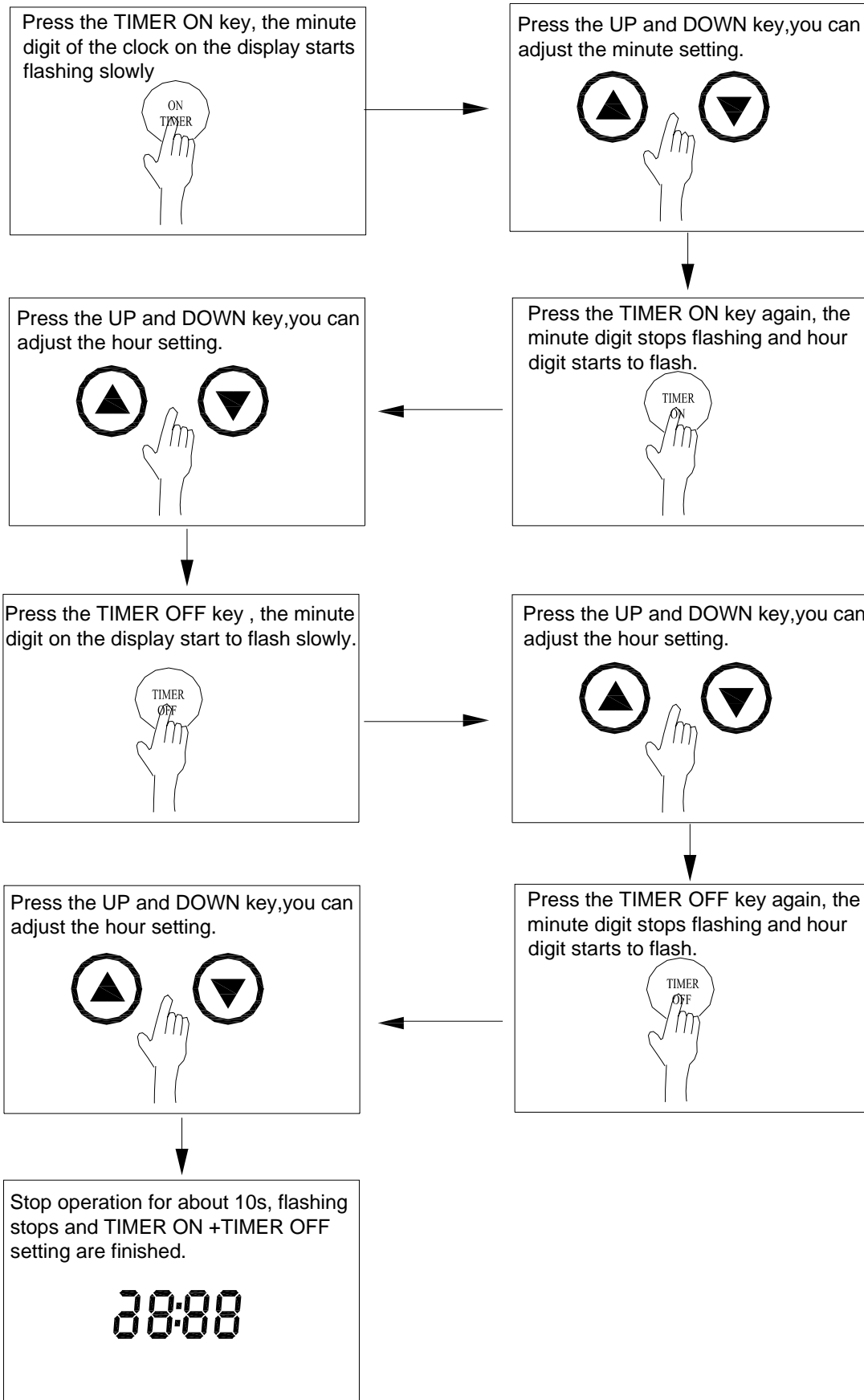

CANCEL:

In the unlocked status, press the CANCEL key for 1s, the TIMER ON and TIMER OFF function will be canceled.

**NOTE:**

- 1) TIMER ON and TIMER OFF can not be set to the same time. If they are the same, the stop time will delay 10 minutes automatically. For example, Time on and Time off set to 1:00 at the same time, then the stop time will adjust to 1:10 automatically.
- 2) TIMER OFF function can not be used alone. The key can be used only after setting the on time.

2.2.4.8 Power On and Power Off

Press Power On/Power Off button after all the above have finished and the system will run as the setting. And simply press the same button to stop it.

**2.2.4.9 Operation status**

The LA code from the screen of set Temp. will appear and remind user when ambient temp. not meet the operation condition of heat pump unit (beyond $-7\sim 43^{\circ}\text{C}$). User can switch the economy mode to E-heating mode in sure of enough volume of hot water if need. The unit will return operation pre-status automatically in no any operation when the ambient temp. meet the operation condition of heat pump mode and the error LA will be disappear at the same time, the screen display normally.

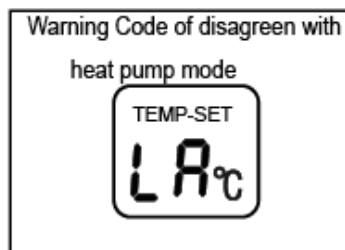
**2.2.4.10 Error Shooting**

If some errors happen, the buzzer will buzz 3 times every other minute and the error indicator will glitter fast. Press CANCEL for several seconds to stop the buzzer but the light will keep glittering.

The light will flash with Alarm



Press CANCEL key to stop the buzzer.



The system will display the error code and the water temperature alternatively on the display in error.

The water temperature and error code will display alternatively



When error happens, though the system could be used in some circumstances, it could not reach the expected efficiency. Please contact your supplier for help. Error Code Explanation (See table below table)

Display	Malfunction Description	Display	Malfunction Description
E0	Error of sensor T5U	P1	System high pressure protection ≥3.0MPa active; ≤2.4Mpa inactive
E1	Error of sensor T5L	P2	High discharge temp. protection Tp>115℃, Protection active Tp<90℃, Protection inactive
E2	Tank and Wired Controller communication error	P3	Open compressor circuit protection (PCB current_induction_circuit check there is no current (I<1A))
E4	(T3) Evaporator output pipe temperature sensor error	P4	Compressor overloaded protection (10 secs after compressor startup, Current checking starts , If it is over 10A lasting for 2sec or over 12A, the compressor will be stopped and protected.) On hybrid mode, when T4<12℃, as well as hot water is consumed too fast, compressor & element will start at the same time, under this condition, if current I>32A, system consider it as current overload protection, shows P4 Or P9
E5	(T4) Outdoor ambient temperature sensor error	P8	When there is no current on element circuit, consider it as element open circuit protection, shows P8, when system OFF, protection inactive
E6	(Tp) Comp. discharge Sensor error	P9	When there is more than 16A current on Element circuit, Element overload current protection active, inactive when system OFF
E7	Heat Pump system error If any of P3/P4/P2/P1 continuously appear 3 times within single heating cycle, system will consider it as “Heat Pump system error”	LA	When the ambient temp is out of Heat Pump running zone [-7~43℃],Heat Pump will stop ,then LA protection code will appear, and ALARM indicator flashes if the condition maintain more than 20hr, Need to switch to Enhanced heating Mode.
E8	Electric leakage error If PCB current_induction_circuit check the current difference between L,N >14mA, system consider it as” electric leakage error”	E9	(Th) Comp. suction Sensor error

2.3 Running and Operating

2.3.1 Trial Running

- 1) Before running, please check the following items first:
- 2) Correct installation of the system;
- 3) Correct connection of pipeline and wiring;
- 4) Leakage of the refrigerant pipeline tested;
- 5) Efficient drainpipe;
- 6) Complete insulation protection;
- 7) Correct earthing;
- 8) Correct power supply;
- 9) No obstacle outside the air inlet and outlet;
- 10) No air in the water pipeline and all valve opened;
- 11) Effective electric leakage protector;
- 12) Sufficient inlet water pressure($\geq 0.15\text{MPa}$)

2.4 Refrigerant figure

2.4.1 System Piping figure

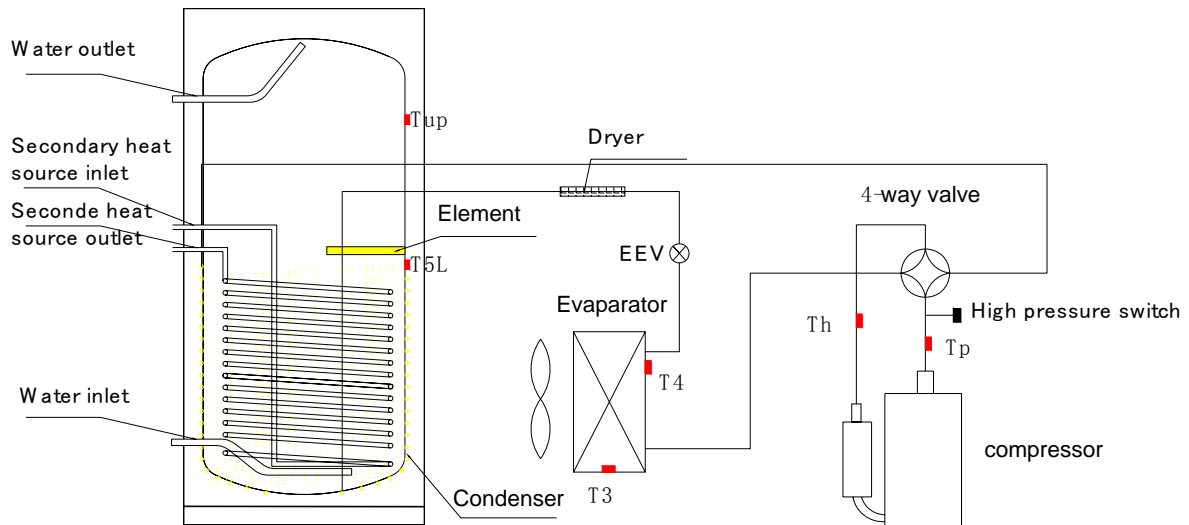

Compressor: Mitsubishi RB233GRDC, R134a; **Element:** located in the mid of tank, 3000W/230VAC;

TCO (Temp. Switch): when water Temp. >80, switch OFF, when water Temp. <60, switch ON;

High Pressure Switch: switch OFF when 3.0MPa; switch ON when 2.4MPa; **Fan:** Centrifugal type, 220V—240V/50Hz, 3 Speeds; **EEV:** Sanhua Φ1.3 EEV; **4-Way Valve:** Hualu STF-02BN2

Compressor crankcase belt heater: DJRD-390A-1300-25W; **Wire controller(Optional):** KJR-90B

manometer (High Pressure Switch)	1	202301800820
Discharge temp sensor ass'y (Tp)	1	202301300130
room temp sensor ass'y (T4)	1	202301300196
Temp.sensor ass'y (T3)	1	202301300437
Temperature sensor (Th)	1	202301300303
senor ass'y, for the pipe (T5L)	1	202301300485
senor ass'y, for the pipe (T5Up)	1	202301300486
Relay of Elment & Compressor	2	202300800003
TCO(turn off temp. $85 \pm 3^{\circ}$ C, manually recovery)	1	202301610028
TOD Auto Recovery, turn off temp. $78 \pm 3^{\circ}$ C, Recovery temp $68 \pm 3^{\circ}$ C.	1	202301600046

2.4.2 System I/O figure

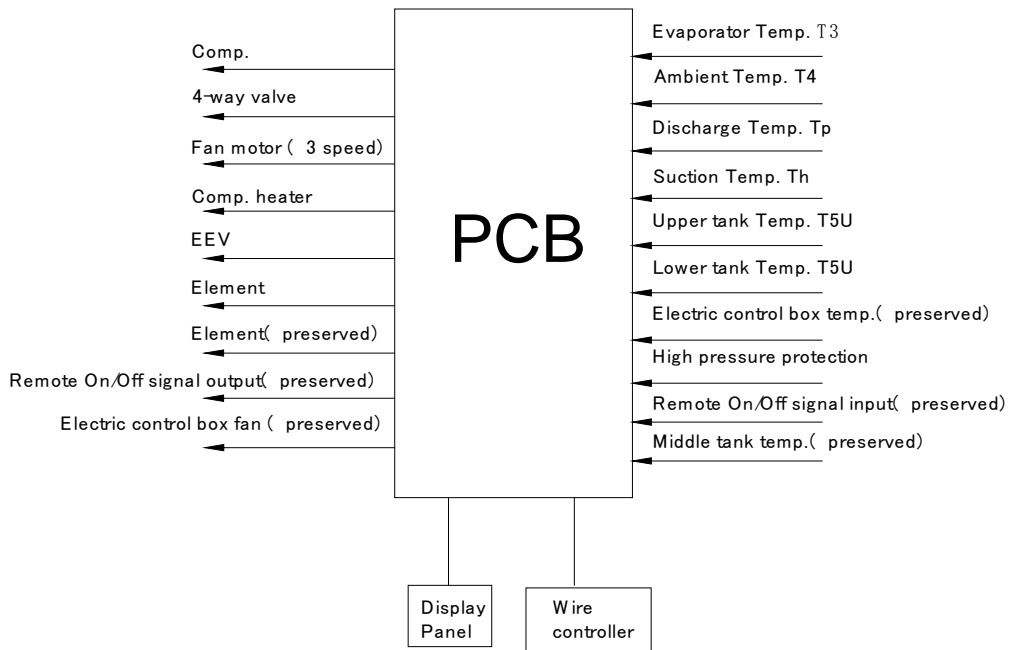

2.4.3 Fan motor speed control

Fan motor speed has 3 levers, High, Middle, Low speed;

Fan motor will start with high speed 30s in advance of the start of compressor;

After starting, Fan motor speed will be regulated by T_p (Compressor discharge temperature) with following logic

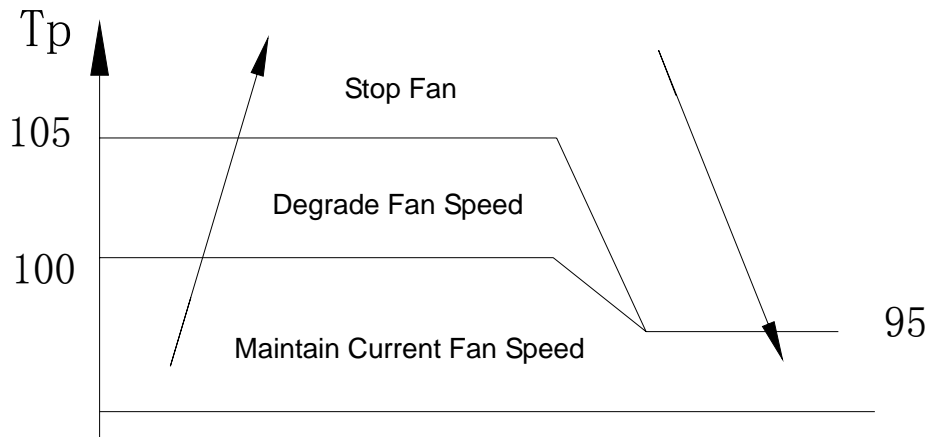

Fan motor will stop 30s behind of the stop of compressor

2.4.4 Defrosting during Water-heating

Conditions to activate defrosting cycle

When $T_3 \leq 0^\circ\text{C}$, Comp. is continually running for 40min

(If Comp. restart frequently, which can only run within 10 min. for each start cycle, system will count accumulated running time, when accumulated running time reaches 40min, defrosting cycle will activate 2 min. after Compressor's next start

Conditions to inactivate defrosting cycle (when achieve any one of following conditions)

1. Defrosting time reaches 10 min;
2. $T_3 \geq 15^\circ\text{C}$;

Main components' movement when defrosting

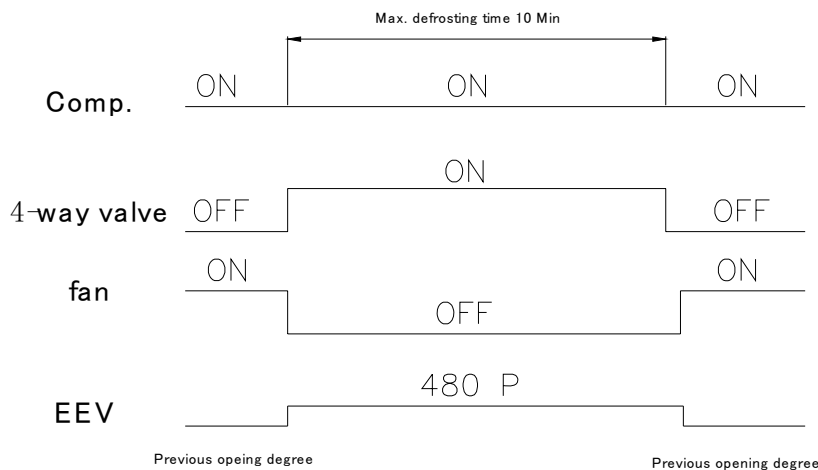

EEV stay 480P opening degree when defrosting, 4min after defrosting EEV start regulating

2.4.5 Ambient Temperature

- a) The system's operation temperature is within $-30\sim 43^\circ\text{C}$ and below are the operation temperature for each mode.
- b) Economy Mode: $-7\sim 43^\circ\text{C}$
- c) Hybrid Mode: $-30\sim 43^\circ\text{C}$
- d) E-heater Mode: $-30\sim 43^\circ\text{C}$

2.4.6 Self-Protection Detection

- a) When the self-protection happens, the system will be stopped and start self-check, and restart when the protection resolved;
- b) When the self-protection happens, the buzzer will buzz in every other minute, the Warning indicator glitter and the display indicate the error code and water temperature alternatively. Press CANCEL button for 3sec to stop the alarm. All stop when he protection is resolved and error code disappears on the display.

- c) In the following circumstances, self-protection starts:

Air inlet or outlet is obstacles;

The heat exchanger is covered with too much dust;

Incorrect power supply (exceeding the range of $220\pm 10\%$)

NOTE: When self-protection happens, cut the power supply manually and restart after the error resolved.

2.4.7 Water Temperature Display

- a) The temperature on the display is the water temperature in upper part of water tank (over 1/4) which you will use, but not that of all the water.

- b) The 6 indicators beside the water temperature on the display are the lower part water temperature. When the temperature is 15°C lower than the set temperature, the blue one will light up; when 10°C lower, the blue and yellow ones light up; when 5°C lower, the blue, yellow and red ones light up and when all light up, the water temperature has reached the set point.
- c) In water using, the temperature of the lower part may decrease while the upper part still keeps a high one, and the system will start heating the lower part. And it is normal.

7 Error Shooting

- a) When common error happens, the system enters Standby Mode and could still work, but not so efficient as normal. Please contact the technician.
- b) When serious error happens, the system will be unable to carry on. Please contact the technician.
- c) When error happens, the buzzer will buzz in every other minute, the Warning light glitter and the display indicate the error code and water temperature alternatively. Press CANCEL button for 3sec to stop the alarm.

2.4.8 Restart after Long Stop

When the system is started after a long time (trial running included), it is normal if the outlet water is unclean. Keep the tap on and it will be clean soon.

3. PCB explanation

2.5 PCB I/O Ports description

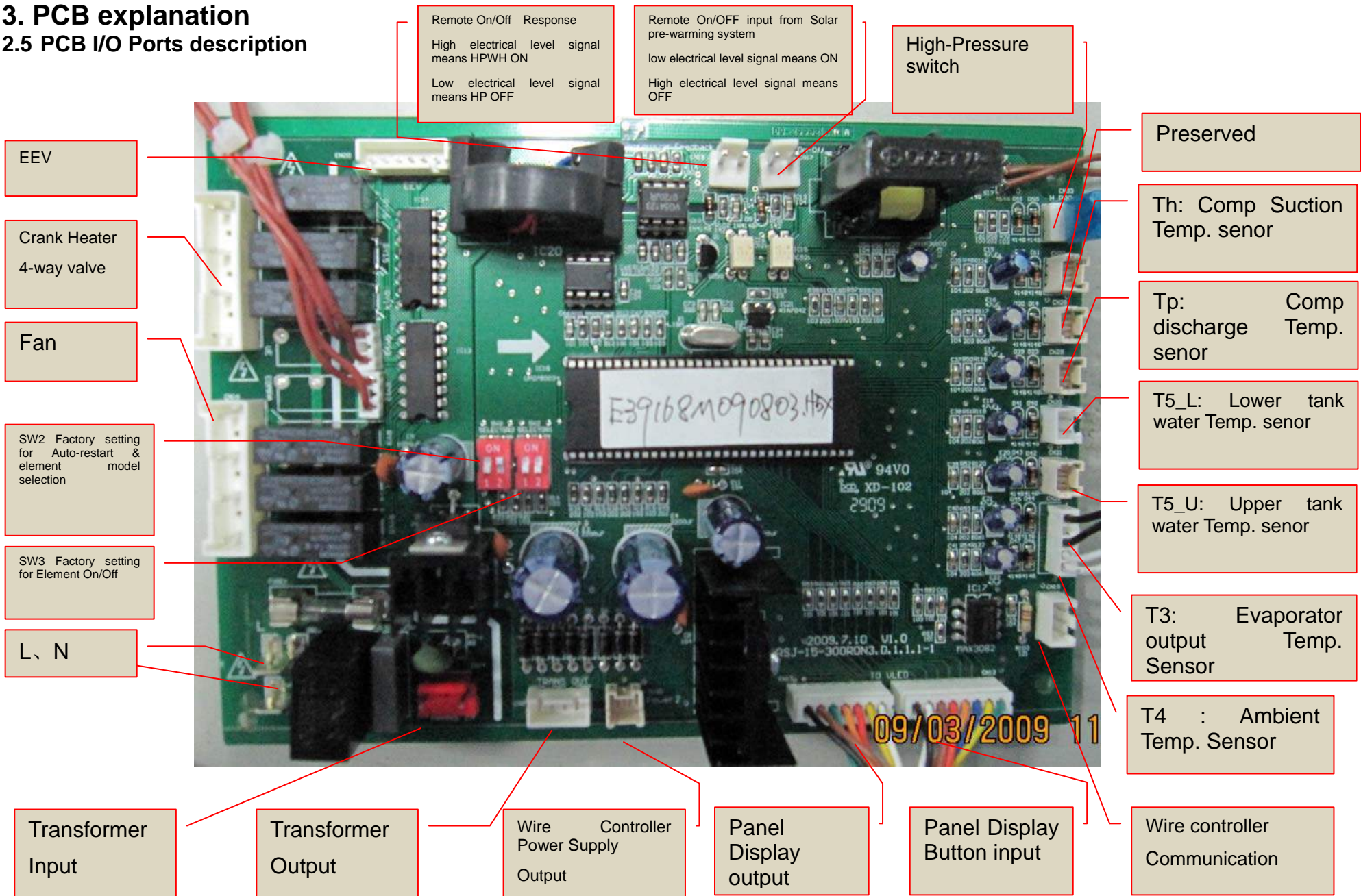

Wiring explanation

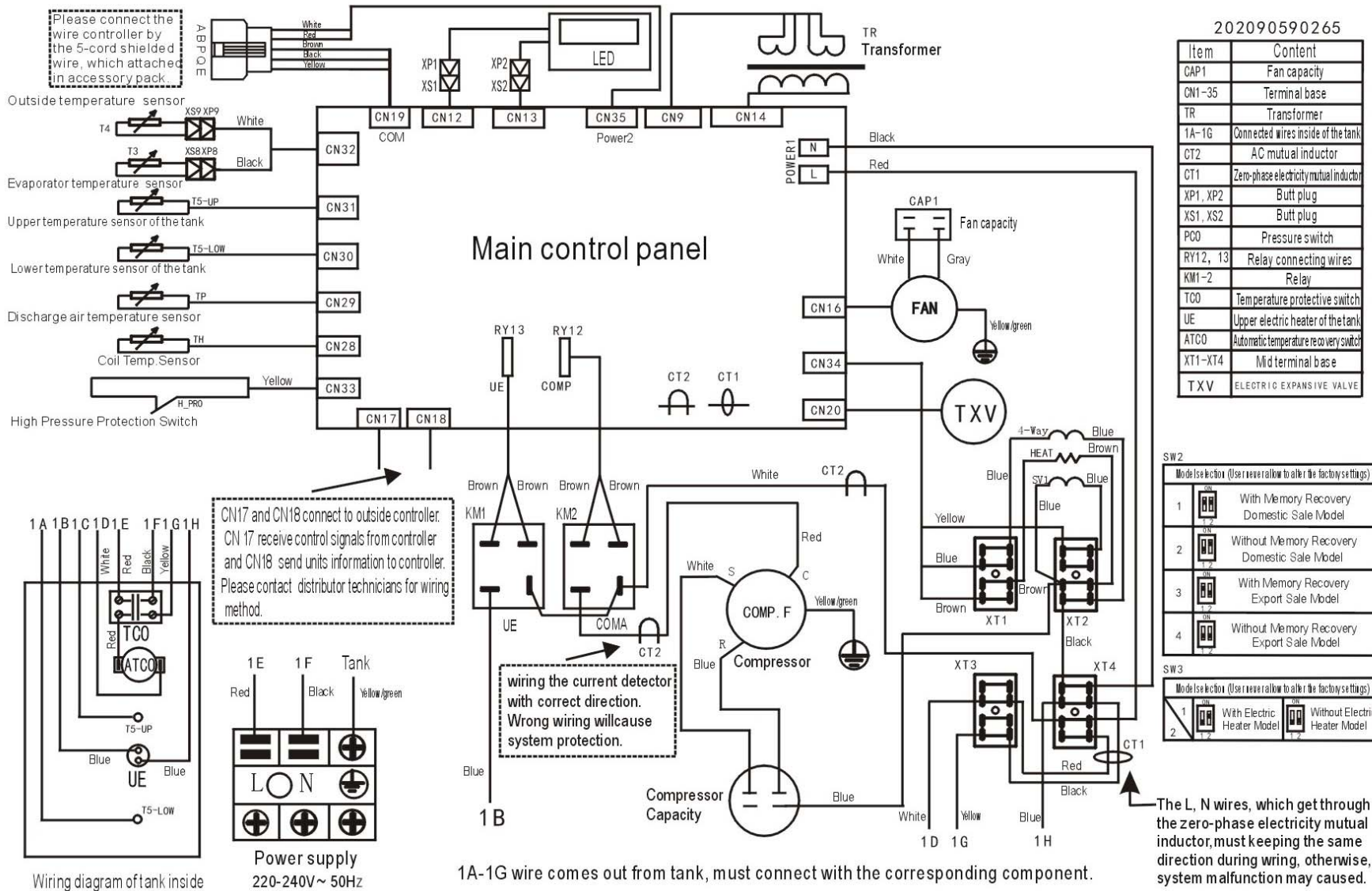

3.2 SW2/SW3 SETTING

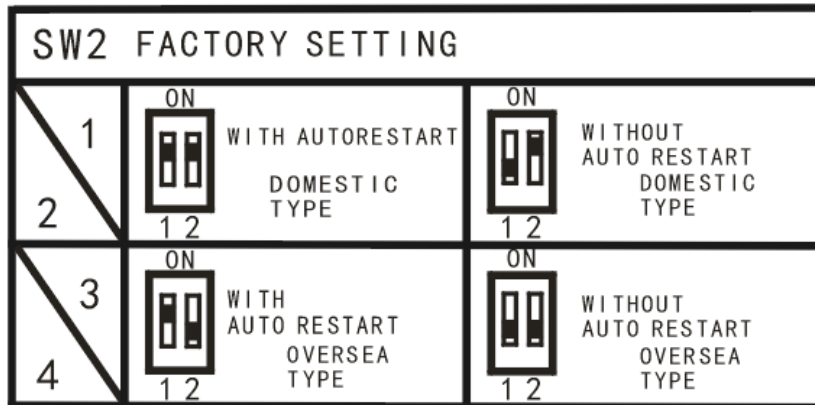

3.3 Self-checking function

How to get in self-checking function?

Press 2 buttons together: “Cancel” + “Clock”

No.	Hour Low bit	Min. High bit	Min. Low bit	Ts High bit	Ts Low bit	Tank Temp. Low	Tank Temp. High	Explanation

						bit	bit	
0	Ⓔ	Ⓔ	L			Temp. valve		T5L Lower Tank Temp
1	Ⓔ	Ⓔ	U			Temp. valve		T5U Upper Tank Temp
2	Ⓔ	4				Temp. valve		T4 Ambient Temp
3	Ⓔ	⊗				Temp. valve		T3 Evaporator Temp
4	Ⓔ	P				Temp. valve		Tp Discharge Temp
5	Ⓔ	H				Temp. valve		Th Suction Temp
6		X	X			Current valve		XX: □ COPM; U ^E Upper Element; LE Lower Element
7	d	d				Opening degree		EEV opening degree, 8 times to real value
8			X					Running mode: Economy, 2 Hybrid, 4 E-heater, 8 Close
9		F	X					Fan speed: F□ stop, F⊗High, F2Mid, F Low
10		□	X					Model: □ domestic type; oversea type
11		X	X					Previous 1 st error or protection code
12	2	X	X					Previous 2 nd error or protection code
13	⊗	X	X					Previous 3 rd error or protection code
14	Y	M	M	D	D			Software version, record by date

4 Maintenance

4.1 Maintenance

- 3.1.1 Check the connection between power supply plug and socket and ground wiring regularly;
- 3.1.2 In some cold area (below 0°C), if the system will be stopped for a long time, all the water should be released in case of freezing of inner tank and damage of e-heater.
- 3.1.3 It is recommended to clean the inner tank and e-heater regularly to keep an efficient performance.

- 3.1.4 Check the sacrificial anode every half year and change it if it has been used out. For more details, please contact the supplier or the after-sale service.
- 3.1.5 It is recommended to set a lower temperature to decrease the heat release, prevent scale and save energy if the outlet water is sufficient.
- 3.1.6 Clean the air filter every month in case of any affect on the heating performance.
- 3.1.7 Before shutting the system down for a long time, please: Shut down the power supply; Release all the water in water tank and the pipeline and close all the valves; Check the inner components regularly.

4.2 Non-error Malfunction

3.2.1 3-min Protection With the power supplied, an immediate restart after the shutting down will have to wait 3 min as to protect the compressor.

3.2.2 If self-protection happens and the system stops, check :

When the power indicator lights up, if the system is forced to run while startup requirement has not been met;

If the air outlet or inlet is jammed or strong wind blows to air outlet.

3.2.3 Defrosting

When it is humid and cold, the condenser may defrost and the water-heating capacity decrease. And the system will stop heating water and start defrosting and then restart water-heating

3.2.4 During defrosting, the compressor keeps running but reverse to defrosting cycle while fan motor stops;

3.2.5 The defrosting time varies from 3min to 10min according to the ambient temperature and the frost.

4.3 Temperature Display

3.3.1 When the system stops, a decrease of the temperature is normal as heat released. When it decreases to some point, the system will restart automatically;

3.3.2 During water-heating, the displayed water temperature might still decrease or not increase for a period of time because of the heat exchange of the water. When the whole tank of water has reached the set temperature, the system will stop automatically.

5 Malfunctions and Resolutions

Malfunction	Cause	Resolutions
Outlet water is cold. The display is dark.	Bad connection of power supply plug and socket; Outlet water is set an a low temperature; Outlet water temperature controller is damaged; Circuit board of indicating indicator is damaged;	Reconnect the plug; Set outlet water an a higher temperature; Contact the technician.
No hot water from the outlet.	Tap water has been cut away; Water pressure is too low; Inlet valve has been closed.	It'll return to normal after water supplied; Use it when the pressure is higher; Open the inlet water valve.
Water leakage	The joints on the pipeline are not sealed well.	Check and reseal all the joints.

If the unit occurs any malfunction or error, please shut down the system, turn off the power supply, and consult your service persons for help.

Appendix 1 Temp.—Resistance Table of TP Sensor

单位: ℃--K		排气温度传感器表					
-20	542.7	20	68.66	60	13.59	100	3.702
-19	511.9	21	65.62	61	13.11	101	3.595
-18	483	22	62.73	62	12.65	102	3.492
-17	455.9	23	59.98	63	12.21	103	3.392
-16	430.5	24	57.37	64	11.79	104	3.295
-15	406.7	25	54.89	65	11.38	105	3.203
-14	384.3	26	52.53	66	10.99	106	3.113
-13	363.3	27	50.28	67	10.61	107	3.025
-12	343.6	28	48.14	68	10.25	108	2.941
-11	325.1	29	46.11	69	9.902	109	2.86
-10	307.7	30	44.17	70	9.569	110	2.781
-9	291.3	31	42.33	71	9.248	111	2.704
-8	275.9	32	40.57	72	8.94	112	2.63
-7	261.4	33	38.89	73	8.643	113	2.559
-6	247.8	34	37.3	74	8.358	114	2.489
-5	234.9	35	35.78	75	8.084	115	2.422
-4	222.8	36	34.32	76	7.82	116	2.357
-3	211.4	37	32.94	77	7.566	117	2.294
-2	200.7	38	31.62	78	7.321	118	2.233
-1	190.5	39	30.36	79	7.085	119	2.174
0	180.9	40	29.15	80	6.859	120	2.117
1	171.9	41	28	81	6.641	121	2.061
2	163.3	42	26.9	82	6.43	122	2.007
3	155.2	43	25.86	83	6.228	123	1.955
4	147.6	44	24.85	84	6.033	124	1.905
5	140.4	45	23.89	85	5.844	125	1.856
6	133.5	46	22.89	86	5.663	126	1.808
7	127.1	47	22.1	87	5.488	127	1.762
8	121	48	21.26	88	5.32	128	1.717
9	115.2	49	20.46	89	5.157	129	1.674
10	109.8	50	19.69	90	5	130	1.632
11	104.6	51	18.96	91	4.849		
12	99.69	52	18.26	92	4.703		
13	95.05	53	17.58	93	4.562		
14	90.65	54	16.94	94	4.426		
15	86.49	55	16.32	95	4.294	R(25/50)=3950K	
16	82.54	56	15.73	96	4.167		
17	78.79	57	15.16	97	4.045	R(90℃)=5KΩ ±-3%	
18	75.24	58	14.62	98	3.927		
19	71.86	59	14.09	99	3.812		

Appendix 2 Temp.—Resistance Table of T3/T4/Tp/T5Up/T5L Sensor

单位: ℃—K		室温、管温传感器表					
-20	115.266	20	12.6431	60	2.35774	100	0.62973
-19	108.146	21	12.0561	61	2.27249	101	0.61148
-18	101.517	22	11.5	62	2.19073	102	0.59386
-17	96.3423	23	10.9731	63	2.11241	103	0.57683
-16	89.5865	24	10.4736	64	2.03732	104	0.56038
-15	84.219	25	10	65	1.96532	105	0.54448
-14	79.311	26	9.55074	66	1.89627	106	0.52912
-13	74.536	27	9.12445	67	1.83003	107	0.51426
-12	70.1698	28	8.71983	68	1.76647	108	0.49989
-11	66.0898	29	8.33566	69	1.70547	109	0.486
-10	62.2756	30	7.97078	70	1.64691	110	0.47256
-9	58.7079	31	7.62411	71	1.59068	111	0.45957
-8	56.3694	32	7.29464	72	1.53668	112	0.44699
-7	52.2438	33	6.98142	73	1.48481	113	0.43482
-6	49.3161	34	6.68355	74	1.43498	114	0.42304
-5	46.5725	35	6.40021	75	1.38703	115	0.41164
-4	44	36	6.13059	76	1.34105	116	0.4006
-3	41.5878	37	5.87359	77	1.29078	117	0.38991
-2	39.8239	38	5.62961	78	1.25423	118	0.37956
-1	37.1988	39	5.39689	79	1.2133	119	0.36954
0	35.2024	40	5.17519	80	1.17393	120	0.35982
1	33.3269	41	4.96392	81	1.13604	121	0.35042
2	31.5635	42	4.76253	82	1.09958	122	0.3413
3	29.9058	43	4.5705	83	1.06448	123	0.33246
4	28.3459	44	4.38736	84	1.03069	124	0.3239
5	26.8778	45	4.21263	85	0.99815	125	0.31559
6	25.4954	46	4.04589	86	0.96681	126	0.30754
7	24.1932	47	3.88673	87	0.93662	127	0.29974
8	22.5662	48	3.73476	88	0.90753	128	0.29216
9	21.8094	49	3.58962	89	0.8795	129	0.28482
10	20.7184	50	3.45097	90	0.85248	130	0.2777
11	19.6891	51	3.31847	91	0.82643	131	0.27078
12	18.7177	52	3.19183	92	0.80132	132	0.26408
13	17.8005	53	3.07075	93	0.77709	133	0.25757
14	16.9341	54	2.95896	94	0.75373	134	0.25125
15	16.1156	55	2.84421	95	0.73119	135	0.24512
16	15.3418	56	2.73823	96	0.70944	136	0.23916
17	14.6181	57	2.63682	97	0.68844	137	0.23338
18	13.918	58	2.53973	98	0.66818	138	0.22776
19	13.2631	59	2.44677	99	0.64862	139	0.22231

